

# CALIBRATION and SERVICING HANDBOOK

Volume 1

**1271**

**selfcal digital multimeter**



# **CALIBRATION and SERVICING HANDBOOK**

for

## **THE DATRON 1271**

### **SELF CAL DIGITAL MULTIMETER**

#### **Volume 1**

#### **Calibration and Servicing Information**

#### **Technical Descriptions**

For any assistance contact your nearest Datron Sales and Service center.  
Addresses can be found at the back of this handbook.

850252

Issue 1 (AUG 1989)

Due to our policy of continuously updating our products, this handbook may contain minor differences in specification, components and circuit design to the actual instrument actually supplied. Amendment sheets precisely matched to your instrument serial number are available on request.

© 1989 Datron Instruments



# Volume 1 Contents

Servicing Diagrams and Component Lists.

Refer to Volume 2

General Description, Installation, Controls, Operation, Applications;  
Specification, Specification Verification and Routine Calibration.

Refer to  
User's Handbook

Section	Title	Page
<b>1</b>	<b>CALIBRATION</b>	
1.1	Routine Calibration References .....	1-1
1.2	Internal Access .....	1-1
1.3	Remote Calibration via the IEEE 488 Interface .....	1-1
1.4	Special Calibration .....	1-1
1.4.1	Entry into the SPCL Menu .....	1-2
1.4.2	Adc Key .....	1-3
1.4.3	Dac Key .....	1-4
1.4.4	Freq .....	1-5
1.4.5	ClrNv .....	1-6
<b>2</b>	<b>GUIDE TO 1271 FAULT DIAGNOSIS</b>	
2.1	Introduction .....	2-1
2.1.1	Use of Error Codes .....	2-1
2.1.2	Code Groupings .....	2-1
2.1.3	'Full' and 'Fast' Selftest .....	2-2
2.1.4	References .....	2-2
2.2	9000 Series Codes - Fatal System Errors .....	2-2
2.2.1	Introduction .....	2-2
2.2.2	Immediate Action .....	2-2
2.2.3	Fatal System Error Codes .....	2-2
2.3	Command Errors .....	2-3
2.4	1000 Series Codes - Execution Errors .....	2-3
2.4.1	Introduction .....	2-3
2.4.2	Execution Error Codes .....	2-3
2.5	2000 Series Codes - Device-Dependent Errors .....	2-4
2.5.1	Introduction .....	2-4
2.5.2	Index of Device-Dependent Error Codes .....	2-5
2.6	2000 Series Codes - Device-Dependent Errors - Localization .....	2-12
2.6.1	Introduction .....	2-12
2.6.2	Access to Error Codes via the 1271 Menu Keys .....	2-13
2.6.3	Composition of the Error Code .....	2-14
2.6.4	External Calibration Operations .....	2-15
2.6.5	Memory Tests .....	2-15
2.6.6	Reference Ratio Tests .....	2-16
2.6.7	DC Voltage Tests .....	2-18
2.6.8	AC Voltage Tests .....	2-26
2.6.9	DC Current Tests .....	2-36
2.6.10	AC Current Tests .....	2-42
2.6.11	Resistor Ratio Tests .....	2-44
2.6.12	Ohms Tests .....	2-50
2.6.13	High Ohms Tests .....	2-54
2.7	Fast Selftest .....	2-56
2.7.1	Memory Tests .....	2-57
2.7.2	Reference Ratio Tests .....	2-57
2.7.3	DC Voltage Tests .....	2-58
2.7.4	AC Voltage Tests .....	2-60
2.7.5	DC Current Tests .....	2-64
2.7.6	AC Current Tests .....	2-66
2.7.7	Resistor Ratio Tests .....	2-68
2.7.8	Ohms Tests .....	2-70

Section	Title	Page
<b>3</b>	<b>DISMANTLING AND REASSEMBLY</b>	
3.1	General Precautions .....	3-1
3.1.1	WARNING .....	3-1
3.1.2	CAUTIONS .....	3-1
3.2	General Mechanical Layout .....	3-1
3.2.1	Front Panel .....	3-1
3.2.2	Rear Panel .....	3-1
3.3	Location and Access .....	3-2
3.3.1	External Construction .....	3-2
3.3.2	Internal Construction .....	3-2
3.4	General Access .....	3-3
3.4.1	Rear Corner Blocks, Top Cover .....	3-3
3.4.2	Rear Corner Blocks, Bottom Cover .....	3-3
3.4.3	Front Bezel .....	3-4
3.4.4	Rear Panel Assembly .....	3-4
3.5	Sub-Assembly Removal and Fitting .....	3-5
3.5.1	Digital PCB .....	3-5
3.5.2	Display PCB .....	3-6
3.5.3	Front Panel Switch PCB .....	3-6
3.5.4	Front Terminal Assembly .....	3-7
3.5.5	DC PCB .....	3-7
3.5.6	AC PCB .....	3-8
3.5.7	Ohms PCB .....	3-8
3.5.8	Current PCB .....	3-8
3.6	Front Terminal Retraction Mechanism .....	3-9
3.7	Transformer Assemblies .....	3-10
3.7.1	Mains (Line) Transformer .....	3-10
3.7.2	Low Voltage Transformer .....	3-11
<b>4</b>	<b>SERVICING</b>	
4.1	Routine Servicing .....	4-1
4.2	Adjustment Following Replacement of PCBs .....	4-1
4.3	Lithium Battery - Replacement .....	4-2
4.3.1	Digital Assembly 400901 - Procedure .....	4-2
4.3.2	Digital Assembly 400740 - Procedure .....	4-3
4.3.3	Return to Use .....	4-3
<b>5</b>	<b>TECHNICAL DESCRIPTIONS</b>	
5.1	Principles of Operation .....	5-3
5.1.1	Simplified Block Diagram .....	5-3
5.1.2	General Description .....	5-3
5.2	PCB Descriptions .....	5-7
5.2.1	DC PCB .....	5-7
5.2.2	AC PCB - Options 12 and 10 .....	5-12
5.2.3	Resistance - Option 20 .....	5-18
5.2.4	DC and AC Current - Option 30 .....	5-23
5.2.5	Analog-to-Digital Conversion .....	5-26
5.2.6	Internal References .....	5-36
5.2.7	Digital Control .....	5-37
5.2.8	Serial Data Interface .....	5-43



## SECTION 1 CALIBRATION

### 1.1 Routine Calibration

The main features of the routine calibration facilities are described in the User's Handbook, covering:

External Calibration	Section 8.
Internal Source Calibration	Section 8.
Self Calibration	Section 4.

### 1.2 Internal Access

The high accuracy of the instrument demands that its internal environment remains undisturbed. The manufacturer's calibration certificate is invalidated if either of the covers is removed; this implies that at least a full External Calibration with Internal Source Characterization must follow any internal access, such as battery-changing, fault-finding or replacement of PCBs. Refer to Section 4.

N.B. Any displayed **CORRECTIONS ON** message refers to **Selfcal** corrections, generated by the most-recent self-calibration. If this was performed before the events mentioned in the above paragraph, then these corrections are not traceable to the new External Calibration and Internal Source Calibration. The message should be regarded as invalid until a new **Selfcal** is performed.

### 1.3 Remote Calibration via the IEEE 488 Interface

The 1271 is designed as a standards multimeter, its levels of accuracy demanding that it be calibrated against primary laboratory standards. The traceabilities of such standards are derived through physical devices which are as yet not remotely programmable, although the calibration facilities of the 1271 are included in its conformity to IEEE 488.2, against a time when such standards are available on the bus.

It is possible to characterize an individual calibration standard such as the Datron model 4708 at the levels required to calibrate a 1271 to its specification. The Datron 'Portocal' system can be programmed to perform these tasks automatically providing a 4708 in the system is adequately characterized. If the 1271 is not required to operate at its full specification, a regular 4708 in a remote system (e.g. Portocal) can easily be programmed to perform this task.

### 1.4 Special Calibration

The main purpose of this section is to describe four Special Calibrations which may be required under certain conditions. These are listed on the SPCL menu, which is accessed via the EXT CAL menu when in CAL mode. They are:

<b>Adc</b>	Calibration of the instrument's main multi-slope analog-to digital converter. Refer to paras 1.4.2.
<b>Dac</b>	Calibration of the digital-to-analog converter used for the optional 'Analog Output' of the instrument. Refer to paras 1.4.3.
<b>Freq</b>	Calibrating the frequency detector responsible for the frequency readout in the <b>SIGNAL FREQUENCY</b> menu, which is accessed via the <b>Monitor</b> hard key then the <b>Freq</b> key in the <b>MONITOR</b> menu. The detector also provides the frequency readout used during <b>SPOT CAL</b> calibration. Refer to paras 1.4.4.
<b>CirNv</b>	Clearing a section of the non-volatile RAM. Refer to paras 1.4.5.

#### Special Calibration following Memory Corruption.

(e.g. When the battery which supplies the non-volatile calibration memory has been changed with the power off - see Section 4)

Section 2 (Fault Diagnosis) describes the device-dependent error codes resulting from internal tests. Error codes which are generated for calibration memory faults are listed on page 2-15.

Some of these refer to individual calibration correction errors, and others to combined errors.

When faced with any of these error codes, please seek advice or assistance from your nearest Datron Service Center.

When it is deemed necessary to carry out special calibration as a result of non-volatile memory corruption, the starting point should be to clear the calibration memory before proceeding with other individual calibrations.

Selecting **CirNv** in the **SPCL** menu transfers to the **CLEAR NV RAM** menu which offers a choice of clearing one or all of three sections of RAM. The selection should be chosen as a result of consultation with technical staff at the service center.

## Special Calibration Procedures

### 1.4.1 Entry into the SPCL Menu

To carry out any of the four special calibrations it is first necessary to enter the SPCL menu via the EXT CAL menu. The EXT CAL menu is protected, and once active, the Caltrig key is enabled. For these reasons, users are referred to the 'Preparation' procedure detailed on page 8-7 of the User's handbook. Further details of the calibration facilities are described in Section 4 of the User's Handbook, beginning on page 4-40; the EXT CAL menu description starts on page 4-49.

#### The EXT CAL Menu

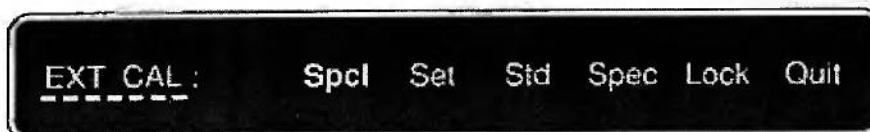

Once the EXT CAL menu is active, pressing the Spcl soft key transfers to the SPCL menu.

#### The SPCL Menu

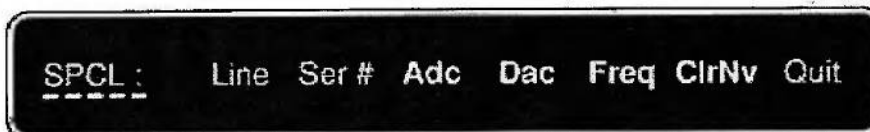

The selection for setting the instrument to the local (50Hz or 60Hz) line frequency, and access for setting the instrument's serial number are also on this menu. We are not concerned with these here; details can be found in the User's Handbook Section 4 page 4-51.

The four special calibrations highlighted in the above menu diagram are described in the following sub-sections 1.4.2 to 1.4.5.

### 1.4.2 Adc Key

*To calibrate the main multi-slope analog-to digital converter.*

The soft Adc key calibrates the different resolutions available from the main A-D converter, so that there are no significant differences in readings seen when changing resolutions with a constant input value.

This calibration is provided for use at manufacture and should need no further adjustment during the life of the instrument. However, if the calibration stores have been cleared or corrupted for any reason (for instance if the battery has been changed with the power off); or if a significant difference is found to exist between measurements of a constant input taken at different resolutions; then Adc calibration may be necessary.

#### 1.4.2.1 To Calibrate:

No equipment is required, and the instrument does not need to be in any particular function or range.

Once in the SPCL menu, merely press the Adc soft key.

#### 1.4.2.2 A-D Modes and Resolution

	Fast-on	Fast-off
resin5+	C	D
resin6+	D	E
resin7+	F	F
resin8+	F	F

#### 1.4.2.3 A-D Modes and Power Line Cycles

A-D Mode	Power Line Cycles
C	312 $\mu$ s
D	1
E	4
F	16



## 1.4.2.4 List of Error Code Numbers

If the A-D calibration is not successful, one of the codes in the following table may be presented on the Menu display. If so, it is possible to re-run the individual test associated with the Error Code. Refer to Section 2, page 2-13 for access to the test pathways. As this is a complex A-D, it is strongly recommended that any problems should be referred to your nearest service center.

Error Code No.	Test Pathway No.	Power Line Freq (Hz)	A-D Mode (Power Line Cycles)	Rdgs (Discd) Avgd	Test Type	Measured Function	Test Limits
2030	PXXY	50	F (16)	(0) 8	Zero Noise	Std. Devn.	< 0.2ppm
2033	PXXV	50	E (4)	(0) 8	Zero Noise	Std. Devn.	< 1ppm
2034	PXXV	50	E (4)	(0) 8	Ext. Zero Noise	Std. Devn.	-200ppmR < 50Hz 4plc Zero < +200ppmR
2035	PXXX	50	D (1)	(0) 8	Zero Noise	Std. Devn.	< 2ppm
2036	PXXX	50	D (1)	(0) 8	Ext. Zero Noise	Std. Devn.	-200ppmR < 50Hz 1plc Zero < +200ppmR
2037	PXXW	50	C (312μs)	(0) 8	Zero Noise	Std. Devn.	< 10ppm
2038	PXXW	50	C (312μs)	(0) 8	Ext. Zero Noise	Std. Devn.	-200ppmR < 50Hz 312μs Zero < +200ppmR
2040	PXXY	60	F (16)	(0) 8	Zero Noise	Std. Devn.	< 0.2ppm
2041	PXXY	60	F (16)	(0) 8	Ext. Zero Noise	Std. Devn.	-200ppmR < 60Hz 16plc Zero < +200ppmR
2044	PXXV	60	E (4)	(0) 8	Zero Noise	Std. Devn.	< 1ppm
2045	PXXV	60	E (4)	(0) 8	Ext. Zero Noise	Std. Devn.	-200ppmR < 60Hz 4plc Zero < +200ppmR
2046	PXXX	60	D (1)	(0) 8	Zero Noise	Std. Devn.	< 2ppm
2047	PXXX	60	D (1)	(0) 8	Ext. Zero Noise	Std. Devn.	-200ppmR < 60Hz 1plc Zero < +200ppmR
2048	PXXW	60	C (312μs)	(0) 8	Zero Noise	Std. Devn.	< 10ppm
2049	PXXW	60	C (312μs)	(0) 8	Ext. Zero Noise	Std. Devn.	-200ppmR < 60Hz 312μs Zero < +200ppmR
2050	PXY Y	50	F (16)	(8) 8	+FR Noise	Std. Devn.	< 0.2ppm
2053	PXYV	50	E (4)	(8) 8	+FR Noise	Std. Devn.	< 1ppm
2054	PXYV	50	E (4)	(8) 8	+FR + Ext. Zero	+FR gain	+FR - 100ppm < 50Hz 4plc +gain< +FR + 100ppm
2055	PXYX	50	D (1)	(8) 8	+FR Noise	Std. Devn.	< 2ppm
2056	PXYX	50	D (1)	(8) 8	+FR + Ext. Zero	+FR gain	+FR - 100ppm < 50Hz 1plc +gain< +FR + 100ppm
2057	PXYW	50	C (312μs)	(8) 8	+FR Noise	Std. Devn.	< 10ppm
2058	PXYW	50	C (312μs)	(8) 8	+FR + Ext. Zero	+FR gain	1.000500 x FR < 50Hz 312μs +gain< 1.001000 x FR
2060	PXY Y	60	F (16)	(8) 8	+FR Noise	Std. Devn.	< 0.2ppm
2063	PXY Y	60	F (16)	(8) 8	+FR + Ext. Zero	+FR gain	+FR - 100ppm < 60Hz 16plc +gain< +FR + 100ppm
2064	PXYV	60	E (4)	(8) 8	+FR Noise	Std. Devn.	< 1ppm
2065	PXYV	60	E (4)	(8) 8	+FR + Ext. Zero	+FR gain	+FR - 100ppm < 60Hz 4plc +gain< +FR + 100ppm
2066	PXYX	60	D (1)	(8) 8	+FR Noise	Std. Devn.	< 2ppm
2067	PXYX	60	D (1)	(8) 8	+FR + Ext. Zero	+FR gain	+FR - 100ppm < 60Hz 1plc +gain< +FR + 100ppm
2068	PXYW	60	C (312μs)	(8) 8	+FR Noise	Std. Devn.	< 10ppm
2069	PXYW	60	C (312μs)	(8) 8	+FR + Ext. Zero	+FR gain	1.000500 x FR < 60Hz 312μs +gain< 1.001000 x FR
2070	PXZY	50	F (16)	(8) 8	-FR Noise	Std. Devn.	< 0.2ppm
2073	PXZV	50	E (4)	(8) 8	-FR Noise	Std. Devn.	< 1ppm
2074	PXZV	50	E (4)	(8) 8	-FR + Ext. Zero	-FR gain	-FR - 100ppm < 50Hz 4plc -gain< -FR + 100ppm
2075	PXZX	50	D (1)	(8) 8	-FR Noise	Std. Devn.	< 2ppm
2076	PXZX	50	D (1)	(8) 8	-FR + Ext. Zero	-FR gain	-FR - 100ppm < 50Hz 1plc -gain< -FR + 100ppm
2077	PXZW	50	C (312μs)	(8) 8	-FR Noise	Std. Devn.	< 10ppm
2078	PXZW	50	C (312μs)	(8) 8	-FR + Ext. Zero	-FR gain	1.000500 x FR < 50Hz 312μs +gain< 1.001000 x FR
2080	PXZY	60	F (16)	(8) 8	-FR Noise	Std. Devn.	< 0.2ppm
2081	PXZY	60	F (16)	(8) 8	-FR + Ext. Zero	-FR gain	-FR - 100ppm < 60Hz 16plc -gain< -FR + 100ppm
2084	PXZV	60	E (4)	(8) 8	-FR Noise	Std. Devn.	< 1ppm
2085	PXZV	60	E (4)	(8) 8	-FR + Ext. Zero	-FR gain	-FR - 100ppm < 60Hz 4plc -gain< -FR + 100ppm
2086	PXZX	60	D (1)	(8) 8	-FR Noise	Std. Devn.	< 2ppm
2087	PXZX	60	D (1)	(8) 8	-FR + Ext. Zero	-FR gain	-FR - 100ppm < 60Hz 1plc -gain< -FR + 100ppm
2088	PXZW	60	C (312μs)	(8) 8	-FR Noise	Std. Devn.	< 10ppm
2089	PXZW	60	C (312μs)	(8) 8	-FR + Ext. Zero	-FR gain	1.000500 x FR < 60Hz 312μs +gain< 1.001000 x FR



## Special Calibration Procedures (Contd.)

### 1.4.3 Dac Key

To calibrate the digital-to-analog converter used for the optional 'Analog Output' of the instrument.

#### Analog Output Calibration

The Analog Output (Option 70) can be provided to give an output scaled from any Function/Range combination to 1V Full Range at low impedance, whose purpose is to drive a logging chart or other recording device.

The Analog Output is calibrated at manufacture, and its accuracy is limited to 0.5% by the resolution of the Digital-to-Analog converter which produces the signal. The stability is such that further calibration of the D-A should be unnecessary during the life of the instrument. However, if the calibration stores have been cleared or corrupted for any reason (for instance if the battery has been changed with the power off); or if an analog output error is suspected to be greater than the specification; then Dac calibration may be required.

#### Calibration Method

Calibration consists of stimulating the D-A from an internal digital source (representing nominal outputs), feeding the analog outputs from the I/O port back to the front panel Hi and Lo terminals (so that an output is known to exist at the I/O port pins) and using the (previously calibrated) 1V DC range to take accurate measurements. The values of these measurements determine digital corrections which are held in non-volatile memory.

No equipment is required other than the external connections shown in the diagram.

Once the external signal path has been connected; the analog output has been enabled; and the 1V DC range has been selected; the calibration can be performed automatically by pressing the **Dac** soft key.

#### To Calibrate:

Ensure that the 1V DC range has already been calibrated.

Connect the Analog Output to the Front Panel Hi and Lo terminals as shown in the diagram. The connection between pins 10 and 15 of SK8 enables the Analog Output.

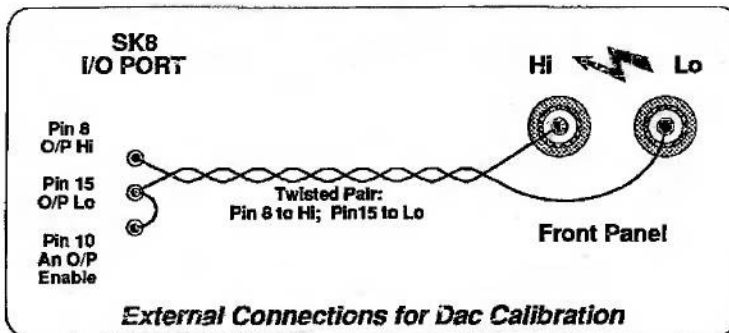

Select the 1V DC range and enter the **SPCL** menu via the **EXT CAL** menu.

Once in the **SPCL** menu, merely press the **Dac** soft key.

## Special Calibration Procedures (Contd.)

### 1.4.4 Freq

To calibrate the frequency detector responsible for the frequency readout in the **SIGNAL FREQUENCY** menu.

#### Frequency Readout Calibration

The frequency of an incoming AC signal can be read out by pressing the **Freq** soft key when in the **MONITOR** menu. The **SIGNAL FREQUENCY** menu appears, with a live frequency reading which changes as the input frequency changes.

*Refer to the User's Handbook starting at page 4-23.*

The frequency detector responsible for the frequency readout is calibrated at manufacture. The frequency stability of the detector is such that further calibration should be unnecessary during the life of the instrument. However, if the calibration stores have been cleared or corrupted for any reason (for instance if the battery has been changed with the power off); or if a frequency error is suspected; then **Freq** calibration may be required.

#### Calibration Method

Calibration consists of taking a measurement of an accurate 1MHz signal on the 1V AC range, and informing the computing system that the frequency is an accurate 1MHz. The measured frequency value contains the measurement error, which is used to determine a digital correction. This is held in non-volatile memory and applied for subsequent frequency readouts.

An accurate 1MHz source is required to provide an external stimulus at between 0.6V and 5.0V peak-to-peak

*Example* Datron Model 4708

Once the external signal is injected; the 1V AC range has been selected; the calibration can be performed automatically by entering the **SPCL** menu via the **EXT CAL** menu and pressing the **Freq** soft key.

#### To Calibrate:

Select the 1V AC range and enter the **SPCL** menu via the **EXT CAL** menu.

Connect an accurate source of 1MHz at between 0.6V and 5.0V peak-to-peak to the Front Panel **HI** and **Lo** terminals.

Press the **Freq** soft key.

## Special Calibration Procedures (Contd.)

### 1.4.5 ClrNv

To clear a section of the non-volatile RAM used for calibration memory.

#### Caution:

Do not clear any section of RAM unless you are sure that it is absolutely necessary. You could destroy an expensive calibration!

### The CLEAR NV RAM Menu

Selecting ClrNv in the SPCL menu transfers to the CLEAR NV RAM menu which offers a choice of clearing one or all of three sections of RAM. The selection should be chosen only as a result of consultation with technical staff at your nearest service center.



#### Menu Choices

- All** Returns all the non-volatile RAM calibration memories to nominal values determined by firmware.
- Ext** Returns the external calibration and internal source characterization memories to nominal values determined by firmware.
- Self** Returns the self calibration memories to nominal values determined by firmware.
- Hf** Returns the calibration memories which hold the AC HF corrections to nominal values determined by firmware.
- Quit** Transfers back to the SPCL menu.



## SECTION 2 GUIDE TO 1271 FAULT DIAGNOSIS

### 2.1 Introduction

#### 2.1.1 Use of Error Codes

The 1271 incorporates an extensive set of error messages, each of which includes a code number. These messages can summarize incorrect application programming via the IEEE 488 bus, or a fault within the

instrument. They are intended to give the user a first indication that all is not well with the measurement which has been set up, and point the way to possible corrective action.

#### 2.1.2 Code Groupings

The instrument is programmed in firmware to monitor its own operation, including interface protocols used via the IEEE 488 bus. As a result it will generate certain error codes to indicate that routine operations (including remote operation and some aspects of external calibration) are unsuccessful. Other error codes can be generated only from internal tests which are part of particular facilities initiated by the user, such as Selftest or Selfcal.

Because the remote operation of the instrument is designed to conform to the IEEE 488.2 standard, the large-scale categories of errors decreed by the standard have been used as the general basis for all error-reporting. This means that error codes and messages reported on the front panel display are consistent, as far as possible, with those reported via the IEEE 488 bus.

The type-names given to groupings of errors are thus primarily determined by those described in the IEEE 488.2 Standard specifications. Some categories apply only to bus operation, and are covered in Section 5 of the User's Handbook. Those which can be useful for diagnosing faults within the instrument are described in this section.

##### Non-Recoverable Errors

For all **Fatal System Errors**, the error condition is reported only via the front panel (this may fail if the fault is severe enough and unfortunately located). The processor stops after displaying the message. A user must respond by first recording any Error Code and accompanying message displayed on the front panel. It is then permissible to power off and restart operation from power on. If this does not clear the error condition, repair should be initiated by communicating with the nearest Datron Service Center.

##### Recoverable Errors

These consist of **Command Errors**, **Execution Errors** and **Device-Dependent Errors**. The reported Execution and Device-Dependent Errors are each identified by a code number, placed in two separate Last-in/First-out queues.

The codes are displayed on the instrument front panel when in local control, or can be accessed at the controller when operating in remote control via the IEEE 488 bus. Many of the messages can be reported by both methods. The code number displayed on the instrument front panel is also accompanied by an error message.

'Command' and 'Execution' errors occur mainly because of incompatible remote programming via the IEEE 488 bus. 'Execution' and 'Device-Dependent' codes can result from specific errors during External Calibration, Self Calibration, Internal Reference parameter characterization or Input Zero operations. Some messages originate whenever a particular type of fault occurs. In addition to these automatic generations, self-testing can obtain a report about deviations from specified performance. Thus whenever it is suspected that a measurement (or a series of measurements) has not been completed successfully, a self test should be run which will either confirm the instrument's performance or localize any problem via the code number system.

## 2.1 Introduction (Contd.)

### 2.1.3 'Full' and 'Fast' Selftest

The front-panel test facilities are summarized in Section 4 of the User's Handbook (page 4-30). Two forms of self-test are available in the TEST menu, obtained by pressing the Test hard key:

#### Full Selftest

This measures the accuracy of all main instrument functions (DCV, ACV, DCI, ACI and Ohms) and ranges of those functions, after checking the internal references and A-D operation. 'PASS' or 'FAIL' results depend on the measurements falling within tolerance limits which reflect the instrument's specification. The accuracy of these tests depends on an initial comparison between the output voltages from the two internal reference modules, and then comparing the ratio of the two against the same ratio which existed at the 'Internal Source Characterization' carried out after the most-recent external calibration to obtain a 'Drift' figure.

#### Fast Selftest

This is a subset of the set of tests allocated to a Full Selftest. It is intended as a quick 'Confidence' check to show that no serious defect is present to affect the instrument's operation. To increase the speed, only the most significant measurements from the full test are included, and most checks are run at reduced resolution (but the comparison between the reference ratio drift measurement is performed at full resolution).

The error code descriptions for Full Selftest are given in sub-section 2.6, and those codes used for Fast Selftest are repeated in sub-section 2.7 for easier access.

### 2.1.4 References in this Section

The messages are interpreted in this section to assist in fault localization:

Fatal System Errors:	2.2
Command Errors:	2.3
Execution Errors:	2.4
Device-Dependent Errors - Index:	2.5
Device-Dependent Errors - Full Test List:	2.6
Device-Dependent Errors - Fast Test List:	2.7

A grouped index of Device-Dependent error codes is given in sub-section 2.5. Each code carries a further reference to specific paragraphs and pages of sub-sections 2.6 and 2.7, in which the relevant element of the self-test responsible for generating the code number is described. Further references to the layout and circuit diagrams of Section 11 in Volume 2 also appear in sub-sections 2.6 and 2.7.

## 2.2 9000 Series Codes - Fatal System Errors

### 2.2.1 Introduction

System errors which cannot be recovered cause the system to halt with a message displayed (the processor stops after displaying the message). The error condition is reported only via the front panel, but this may fail if the fault is severe enough and unfortunately located.

### 2.2.2 Immediate Action

1. Record any Error Code and accompanying message displayed on the front panel. Also record the hardware environment and any operations in progress at the time of failure. Fatal System errors are generally caused by hardware or software faults.
2. Power OFF and ON again to try to restart operation.
3. If (2) is unsuccessful, power OFF again and allow the instrument to cool for 15 minutes; then try powering ON.
4. If the error condition does not recur, repeat the original operations. Check that no temperature or configuration factors cause the error condition to return. If successful, carefully proceed with further measurements as required.
5. If (2) or (3) do not clear the error condition, or if it recurs in (4); communicate with your nearest Datron Service Center, quoting the recorded data from (1), and any other details. A form of failure report is given on the sheet inside the rear cover of this handbook.

### 2.2.3 Fatal System Error Codes

Code	Type of Fault
9000	System Kernel Fault
9001	Run Time System Error
9002	Unexpected Exception
9003	PROM Sumcheck Failure
9004	RAM Check Failure
9005	Serial Interface Fault
9006	Option Test Failure
9007	Unknown Engine Instruction
9099	Undefined Fatal Error



## 2.3 Command Errors

Command Errors are reported in remote operation over the IEEE 488 bus. They are generated when the command has been 'parsed', but does not conform, either to the device command syntax, or to the IEEE 488.2 generic syntax.

The CMB bit (5) is set true in the Standard-defined Event Status Byte, but there is no associated queue so no index can be given. The error is reported by the mechanisms described in the sub-section dealing with status reporting, in Section 5 of the User's Handbook.

## 2.4 1000 Series Codes - Execution Errors

### 2.4.1 Introduction

An Execution Error is generated if a command is recognized as valid (ie can be parsed and does not generate a Command Error), but cannot be executed because it is incompatible with the current device state, or because it attempts to command parameters which are out-of-limits.

#### Local Operation

Most normal operations, from the front panel, lock out the conditions which would give rise to Execution errors, by the choices not being offered in the appropriate menus. However, some selections can be made using hard keys (such as pressing ACV when the option is not present in the instrument) which cannot be locked out. In these cases the Execution error is used as an aide-memoire for the user's convenience. The error code number appears on the front-panel Menu display, accompanied by an error message.

#### Remote Operation

The EXE bit (4) is set true in the Standard-defined Event Status Byte, and the error code number is appended to the Execution Error queue. The error is reported by the mechanisms described in the sub-section dealing with status reporting in Section 5 of the User's Handbook, and the queue entries can be read destructively as LIFO by the Common query command \*EXQ?.

### 2.4.2 Execution Error Codes

Code	Type of Error
1000	EXE queue empty when recalled
1001	Option not installed
1002	Calibration disabled
1003	Ratio/Function combination not allowed
1004	Filter incompatible with Function
1005	Input Zero not allowed
1006	Calibration not allowed in Ratio
1007	Data entry error
1008	Must be in AC Function
1009	Pass Number entry error
1010	Divide-by-zero not allowed
1011	Must be in SpotF Function
1012	No more errors in the queue
1013	Data out of limit
1014	Illegal Range/Function combination
1015	Command allowed only in Remote
1016	Not in Special Calibration
1017	Calibration not allowed with Math
1018	Key not in the Cal Enabled position
1019	Spec not compatible with Function
1020	Internal Source Cal required
1021	Test not allowed when Cal enabled
1022	No parameter for this Function

## 2.5 2000 Series Codes - Device-Dependent Errors - Index

### 2.5.1 Introduction

A Device-Dependent Error is generated if the device detects an internal operating fault (eg. during Selfcal or Selftest). The DDE bit (3) is set *true* in the Standard-defined Event Status Byte, and the error code number is appended to the Device-Dependent Error queue.

#### Remote Operation

In Remote, the error is reported by the mechanisms described in the subsection dealing with status reporting in Section 5 of the User's Handbook, and the queue entries can be read destructively as LIFO by the query DDQ?

#### Local Operation

In Local, the Device-Dependent Error queue is checked at the end of the operation (eg. Cal, Zero, Test). If *true*, an error has occurred, and the contents of the most-recent entry in the queue is displayed on the front panel. The act of displaying the message deletes its code from the queue, so the next most-recent code comes to the front of the queue and is available to be displayed. The queue must be empty for normal operation to continue.

If both bus and front panel users attempt to read the queue concurrently, the data is read out destructively on a first-come, first-served basis. Thus one of the users cannot read the data on one interface as it has already been destroyed by reading on the other. This difficulty should be solved by suitable application programming to avoid the possibility of a double readout. Ideally the IEEE 488 interface should set the instrument into REMS or RWLS to prevent confusion. The bus can ignore the queue, but the front panel user will have to read it to continue.

~~C007~~  
C015  
Link  
5V  
5V ripple  
005 Per +5V supply > 100mV  
102 common  
DIGITAL ASSY  
16V 2200 uF 25V  
C513  
C514

## 2.5.2 Index of Device-Dependent Error Codes

Code	Immediate Action	Full Test Reference Sect.	Full Test Reference Page	Fast Test Reference Sect	Fast Test Reference Page
<b>Memory Tests</b>					
2000		2.6.4.1	2-15		
2001		2.6.4.1	2-15		
2002		2.6.4.1	2-15		
2003		2.6.4.1	2-15		
2004		2.6.4.1	2-15		
2005		2.6.4.1	2-15		
2006		2.6.4.1	2-15		
2008		2.6.4.1	2-15		
2009		2.6.4.1	2-15		
2010		2.6.4.1	2-15		
2011		2.6.4.1	2-15		
2012		2.6.4.1	2-15		
2013		2.6.4.2	2-15		
2014		2.6.4.2	2-15		
2015		2.6.4.2	2-15		
2016		2.6.4.2	2-15		
2017		2.6.4.2	2-15		
2018		2.6.4.2	2-15		
2019		2.6.4.2	2-15		
2020		2.6.4.2	2-15		
2021		2.6.4.2	2-15		
2022		2.6.4.2	2-15		
30-2089		1.4.2	1-3		
2100*		2.6.5.1	2-15	2.7.1.1	2-57
2101*		2.6.5.1	2-15	2.7.1.1	2-57
2102*		2.6.5.1	2-15	2.7.1.1	2-57
2103*		2.6.5.1	2-15	2.7.1.1	2-57
<b>Fuse Tests</b>					
2111*		2.6.5.2	2-1	2.7.1.2	2-57
<b>Reference Ratio Tests</b>					
2121*		2.6.6	2-16	2.7.2	2-57
2122*		2.6.6	2-16	2.7.2	2-57
2131*		2.6.6	2-16	2.7.2	2-57
2132*		2.6.6	2-16	2.7.2	2-57
2141*		2.6.6	2-16	2.7.2	2-57
2142*		2.6.6	2-16	2.7.2	2-57
2143		2.6.6	2-16		
2151*		2.6.6	2-16	2.7.2	2-57
2152*		2.6.6	2-16	2.7.2	2-57
2153*		2.6.6	2-16	2.7.2	2-57
2154*		2.6.6	2-16	2.7.2	2-57
2155		2.6.6	2-16		
2156		2.6.6	2-16		

Section 2 - Fault Diagnosis

Code	Immediate Action	Full Test Reference Sect.	Full Test Reference Page	Fast Test Reference Sect	Fast Test Reference Page
<b>DC Voltage Tests</b>					
2161		2.6.7.1	2-18		
2162		2.6.7.1	2-18		
2163		2.6.7.1	2-18		
2171		2.6.7.1	2-18		
2172		2.6.7.1	2-18		
2173		2.6.7.1	2-18		
2181*		2.6.7.1	2-18	2.7.3.1	2-58
2182*		2.6.7.1	2-18	2.7.3.1	2-58
2183		2.6.7.1	2-18		
2191		2.6.7.1	2-18		
2192		2.6.7.1	2-18		
2193		2.6.7.1	2-18		
2201		2.6.7.1	2-18		
2202		2.6.7.1	2-18		
2203		2.6.7.1	2-18		
2211*		2.6.7.2	2-20	2.7.3.2	2-58
2212*		2.6.7.2	2-20	2.7.3.2	2-58
2213*		2.6.7.2	2-20	2.7.3.2	2-58
2214*		2.6.7.2	2-20	2.7.3.2	2-58
2215*		2.6.7.2	2-20	2.7.3.2	2-58
2216*		2.6.7.2	2-20	2.7.3.2	2-58
2221		2.6.7.3	2-22		
2222		2.6.7.2	2-22		
2223		2.6.7.2	2-22		
2224		2.6.7.2	2-22		
2231		2.6.7.2	2-22		
2232		2.6.7.2	2-22		
2233		2.6.7.2	2-22		
2234		2.6.7.2	2-22		
2241		2.6.7.2	2-22		
2242		2.6.7.2	2-22		
2251		2.6.7.2	2-22		
2252		2.6.7.2	2-22		
2253		2.6.7.2	2-22		
2261		2.6.7.2	2-22		
2262		2.6.7.2	2-22		
2263		2.6.7.2	2-22		
2271		2.6.7.2	2-24		
2272		2.6.7.2	2-24		
2273		2.6.7.2	2-24		
2281*		2.6.7.2	2-24	2.7.3.3	2-58
2282*		2.6.7.2	2-24	2.7.3.3	2-58
2283		2.6.7.2	2-24		
2291		2.6.7.2	2-24		
2292		2.6.7.2	2-24		
2293		2.6.7.2	2-24		



## Section 2 - Fault Diagnosis

Code	Immediate Action	Full Test Reference Sect.	Full Test Reference Page	Fast Test Reference Sect	Fast Test Reference Page
<b>AC Voltage Tests</b>					
2301		2.6.8.1	2-26		
2302		2.6.8.1	2-26		
2311*		2.6.8.1	2-26	2.7.4.1	2-60
2312*		2.6.8.1	2-26	2.7.4.1	2-60
2321*		2.6.8.1	2-26	2.7.4.1	2-60
2322*		2.6.8.1	2-28	2.7.4.1	2-60
2331		2.6.8.1	2-26		
2332		2.6.8.1	2-26		
2341*		2.6.8.1	2-26	2.7.4.1	2-60
2342*		2.6.8.1	2-26	2.7.4.1	2-60
2351		2.6.8.1	2-28		
2352		2.6.6.1	2-28		
2361		2.6.8.1	2-28		
2362		2.6.8.1	2-28		
2371		2.6.8.1	2-28		
2372		2.6.8.1	2-28		
2381		2.6.8.1	2-28		
2382		2.6.8.1	2-26		
2391		2.6.8.1	2-28		
2392		2.6.8.1	2-28		
2401		2.6.8.1	2-28		
2402		2.6.8.1	2-28		
2411		2.6.8.2	2-30		
2412		2.6.8.2	2-30		
2421*		2.6.8.2	2-30	2.7.4.2	2-62
2422*		2.6.8.2	2-30	2.7.4.2	2-62
2431*		2.6.8.2	2-30	2.7.4.2	2-62
2432*		2.6.8.2	2-30	2.7.4.2	2-62
2433		2.6.8.2	2-30		
2434		2.6.8.2	2-30		
2435		2.6.8.2	2-30		
2436		2.6.8.2	2-30		
2437		2.6.8.2	2-30		
2438		2.6.8.2	2-30		
2441		2.6.8.2	2-32		
2442		2.6.8.2	2-32		
2451		2.6.8.2	2-32		
2452		2.6.8.2	2-32		
2453		2.6.8.2	2-32		
2461		2.6.8.2	2-32		
2462		2.6.6.2	2-32		
2471*		2.6.8.2	2-32	2.7.4.2	2-62
2472*		2.6.8.2	2-32	2.7.4.2	2-62
2473		2.6.8.2	2-32		
2481		2.6.8.2	2-34		
2482		2.6.8.2	2-34		
2491*		2.6.8.2	2-34	2.7.4.2	2-62
2492*		2.6.8.2	2-34	2.7.4.2	2-62
2493		2.6.8.2	2-34		
2501		2.6.8.2	2-34		
2502		2.6.8.2	2-34		
2511*		2.6.8.2	2-34	2.7.4.2	2-62
2512*		2.6.8.2	2-34	2.7.4.2	2-62
2513		2.6.8.2	2-34		



**Section 2 - Fault Diagnosis**

<b>Code</b>	<b>Immediate Action</b>	<b>Full Test Reference</b>		<b>Fast Test Reference</b>	
		<b>Sect.</b>	<b>Page</b>	<b>Sect</b>	<b>Page</b>
<b>DC Current Tests</b>					
2521		2.6.9	2-36		
2522		2.6.9	2-36		
2523		2.6.9	2-36		
2524		2.6.9	2-36		
2525		2.6.9	2-36		
2531*		2.6.9	2-36	2.7.5	2-64
2532*		2.6.9	2-36	2.7.5	2-64
2533		2.6.9	2-36		
2541		2.8.9	2-38		
2542		2.6.9	2-38		
2543		2.6.9	2-38		
2551*		2.6.9	2-38	2.7.5	2-64
2552*		2.6.9	2-38	2.7.5	2-64
2553		2.6.9	2-38		
2561		2.6.9	2-38		
2562		2.6.9	2-38		
2563		2.6.9	2-38		
2571*		2.6.9	2-38	2.7.5	2-64
2572*		2.6.9	2-38	2.7.5	2-64
2573		2.6.9	2-38		
2581		2.6.9	2-40		
2582		2.6.9	2-40		
2583		2.6.9	2-40		
2591*		2.6.9	2-40	2.7.5	2-64
2592*		2.6.9	2-40	2.7.5	2-64
2593		2.6.9	2-40		
2601		2.6.9	2-40		
2602		2.6.9	2-40		
2603		2.6.9	2-40		
2611*		2.6.9	2-40	2.7.5	2-64
2612*		2.6.9	2-40	2.7.5	2-64
2613		2.6.9	2-40		

**Section 2 - Fault Diagnosis**

Code	Immediate Action	Full Test Reference Sect.	Reference Page	Fast Test Reference Sect	Reference Page
<b>Ohms Tests</b>					
2741		2.6.12	2-46		
2742		2.6.12	2-46		
2743		2.6.12	2-46		
2751*		2.6.12	2-46	2.7.7	2-70
2752*		2.6.12	2-46	2.7.7	2-70
2753*		2.6.12	2-46	2.7.7	2-70
2754*		2.6.12	2-46	2.7.7	2-70
2755		2.6.12	2-46		
2761		2.6.12	2-46		
2762		2.6.12	2-46		
2763		2.6.12	2-46		
2771		2.6.12	2-48		
2772		2.6.12	2-48		
2773		2.6.12	2-48		
2781*		2.6.12	2-48	2.7.7	2-70
2782*		2.6.12	2-48	2.7.7	2-70
2783		2.6.12	2-48		
2791		2.6.12	2-48		
2792		2.6.12	2-48		
2793		2.6.12	2-48		
2801		2.6.12	2-48		
2802		2.6.12	2-48		
2803		2.6.12	2-48		
2811		2.6.12	2-50		
2812		2.6.12	2-50		
2813		2.6.12	2-50		
2821*		2.6.12	2-50	2.7.7	2-70
2822*		2.6.12	2-50	2.7.7	2-70
2823		2.6.12	2-50		
2831		2.6.12	2-52		
2832		2.6.12	2-52		
2833		2.6.12	2-52		
2841		2.6.12	2-52		
2842		2.6.12	2-52		
2843*		2.6.12	2-52	2.7.7	2-70
2844*		2.6.12	2-52	2.7.7	2-70
2845		2.6.12	2-52		
2851		2.6.12	2-52		
2852		2.6.12	2-52		
2853		2.6.12	2-52		
2861		2.6.12	2-52		
2862		2.6.12	2-52		
2863		2.6.12	2-52		
<b>High Ohms Tests</b>					
2871		2.6.12	2-54		
2872		2.6.12	2-54		
2873		2.6.12	2-54		
2901		2.6.13	2-54		
2902		2.6.13	2-54		
2903		2.6.13	2-54		
2911		2.6.13	2-54		
2912		2.6.13	2-54		
2913		2.6.13	2-54		

## **2.6 2000 Series Codes - Device-Dependent Errors - Localization**

*Codes used for Internal Source Cal, Selfcal and Full Test Start Overleaf*

*Codes used for Fast Test are in Sect 2.7, Starting on Page 2-56*

## 2.6 2000 Series Codes - Device-Dependent Errors - Localization

(Codes used for Fast Test are in Sect 2.7)

### 2.6.1 Introduction

The 1271 firmware incorporates a program to run a comprehensive Self Test of the instrument's operating parameters, utilizing an internal reference as a source to stimulate measurements for the test.

There are two versions of the test: a full check of all parameters against the published specification, whose run time is about 10 minutes (for an instrument fully-loaded with all options); and a faster check of selected parameters, usually with reduced accuracy at a 'Confidence' level, which takes only 1 minute to run. Failure to meet the accuracy tolerance for any one of the parameters will generate an error code.

Error codes for parameter failures are stored in a queue to which the user has access. Sub-section 2.5 is merely an easy-access index which provides immediate-action information and refers to sub-sections 2.6 and 2.7 which deal with 'Device-Dependent Errors', related directly to the internal operations of the 1271 itself.

The purpose of this sub-section is to identify the nature of each test and the part of the instrument which is being checked; to show test paths, with stimulation and measurement points; and to define the tolerance limits for each check. For each test that can generate an error code, references identify and locate the stimulation and measurement points on the layout and circuit diagrams in Volume 2 of this handbook.

The meanings of 'Fatal System Error', 'Command Error' and 'Execution Error' codes are described Section 5 of the User's Handbook, as they are concerned mainly with IEEE 488 operations.

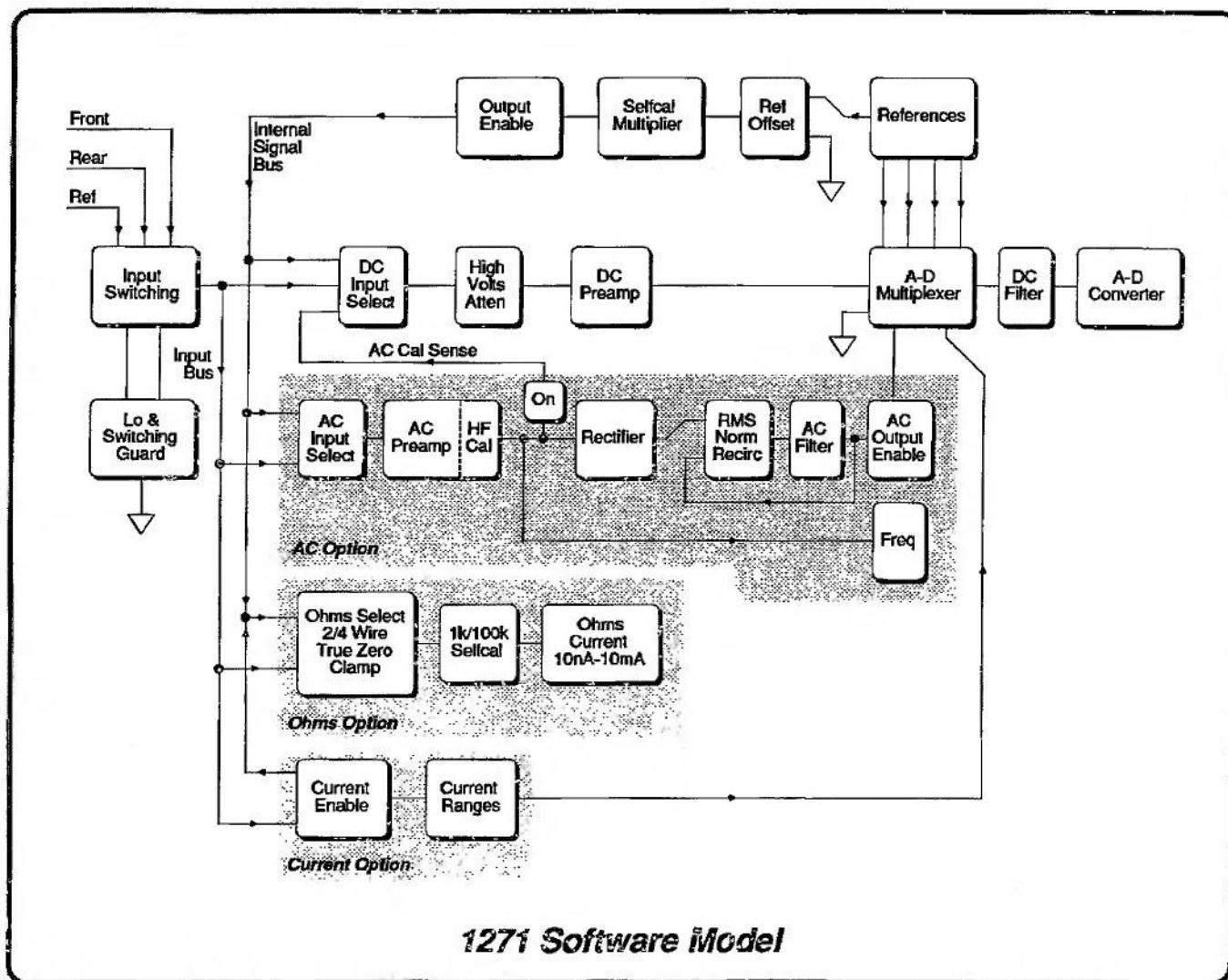



## 2.6.2 Access to Error Codes via the 1271 Menu Keys

(Refer to the User's Handbook, Page 4-31)

### 2.6.2.1 Reading the Error Codes

Each of the two forms of self test runs at high speed, and does not stop unless it is aborted by the user. The error code for the first failure is noted on the Menu display, and this does not change on completion of the self test when the failure menu is displayed. At this point the user can list the codes for all the failures, reading them onto the Menu display in the order last-in, first-out (LIFO). Once an error appears on the display, it is deleted from the queue and cannot be recalled again, so the code numbers should be noted as they appear.

When the self test has stopped, and the error code numbers have been noted, it is possible to access information about each test. Each error code is associated with a unique test pathway, which is numbered, the path number being shown on the tables (indexed by error code).

### 2.6.2.2 Access to Pathway Information

Certain menu keys allow a user to select path numbers. For each selection the live measurement readings for the path are presented on the Main Display, and can be compared against the limits shown in the table which carries the path number.

The path measurement reading on the Main Display is normalized to the range which was already selected. So before using the pathway keys it is advisable to select the 1V DC range, to obtain a *normalized* reading which only requires the range multiplier to be implemented to obtain the reading in the same form as in the table.

The method of accessing the path numbers and associated pathway information is illustrated in the following diagrams.

### Select the 1V DC Range



Press the DCV key and then the '1V' soft key:

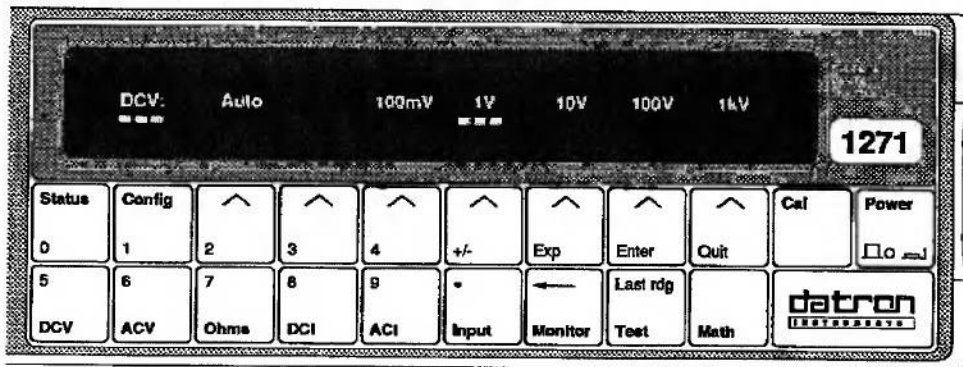

### Select the Pathway Facility



Press the Status key, then the Config key; and finally the soft key labelled '+/-'

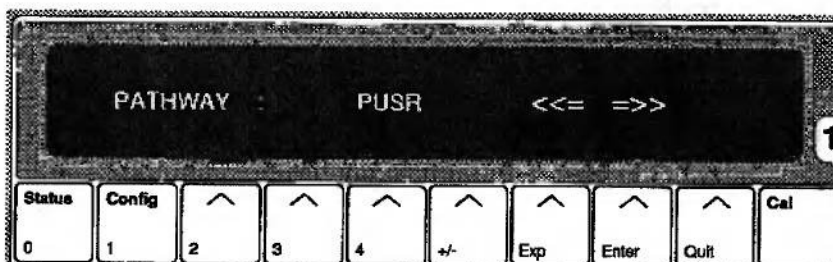

PUSR indicates that the present pathway is as defined by the user's previous selection of front panel keys;

- <<= (Exp) decrements the path number by 1;
- +/- decrements the path number by 20;
- (Enter) increments the path number by 1.
- (Quit) increments the path number by 20.

Press the =>> soft key once. This reveals the number of power-line cycles in use by the A-D. For the basic 1V DC range it will show PL 16.

Press the =>> soft key a second time. This selects pathway P001; the next press selects pathway P002, and so on.



## 2.6.3 Composition of the Error Code

### 2.6.3.1 4-Digit Significance

The codes for these operations are the individual test numbers in the sequence of checks or calibrations implemented by the processor. They will appear as Error Codes only if the process has not been successful, providing data for fault diagnosis. If the fault cannot be diagnosed locally, the data should be recorded and reported for interpretation to your nearest Datron Service Center.

The four-figure code numbers for these operations are constructed as follows:

There are four decimal digits; say w, x, y and z such that in the number wxyz:

- w identifies the code as belonging to the device-dependent group - always 2;
- xy is a two-digit step number, as listed in the tables;
- z is both the measurement number and error number, of which several can be allocated within each step. Each error number is defined only for its own measurement.

### 2.6.3.2 Test Descriptions

A 'Path' number (a 3-figure number prefixed by a capital 'P') describes a single test arrangement, in which several readings are taken. A first group of readings (number of readings depends on the setup) is discarded to allow settling to take place. A second group is then taken to establish a statistical field of results. Significant measurements are made by processing the results through different digital calculations to derive up to three main characteristics:

**Standard Deviation:**

gives a noise figure;

**Mean Value:**

provides mean magnitude;

**Mean minus the Previously-Calibrated Mean:**

is a measure of the mean magnitude drift since the most-recent Internal Source Calibration.

Each characteristic results from a single measurement which, if selected for checking, is compared against specific limits of tolerance allocated in that particular setup for the characteristic. Each selected check constitutes a single measurement in the testing sequence to which a measurement number is attached: this number becomes the Error Code if the step result exceeds its tolerance limits.

### 2.6.3.3 Tables

In the following pages the list of measurements carried out during a test sequence are grouped as a table on the right page of each opening. Each table is associated with a test setup diagram on the facing left page. The tables are arranged in groups, each group being associated with a single main signal route through the main software model, from which the individual test setup diagrams are derived. Small variations of the route (due to switching within the blocks) are listed as numbered test 'paths'. These are not detailed further, as the switching information is contained within the setup description.

The tables give the test path number; test type; points of stimulus and measurement; number of readings discarded and processed; and the tolerance limits allocated to each measurement.

References to Layout and Circuit diagrams allow rapid access to the stimulus and measurement nodes.

The measurements are listed in the tables in error-code sequence. Those appearing in sub-section 2.6 are all included in 'Full Selftest', 'Selfcal' and 'Internal Source Cal'. But not all are included in 'Fast Selftest'. Sub-section 2.7 lists those measurements which form the Fast Selftest. For these steps, the Fast Selftest limits are wider than for Full Selftest, Selfcal or Internal Source Cal. Also, because of the lower resolution in Fast Selftest, more readings can be taken in the same number of line cycles. Generally, different path numbers are allocated to Fast Selftest measurements.

**Note** Abbreviations:

FR = Full Range (Nominal).

FS = Full Scale.

**2.6.4 External Calibration Operations**

**6.4.1 Correction Errors**

- 2000 Zero
- 2001 Gain+
- 2002 Gain-
- 2003 HF trim
- 2004 Input
- 2005 Lol Zero
- 2006 Lol Gain
- 2008 A-to-D
- 2009 Reference
- 2010 Frequency
- 2011 D-to-A
- 2012 Standardize

**2.6.4.2 Corruptions**

- 2013 Key/Pass# flags
- 2014 Serial Number
- 2015 Cal Due Date
- 2016 Self-corrections flag
- 2017 Bus Address
- 2018 Line Frequency
- 2019 Bad data from analog sub-system
- 2020 Measurement corrections corrupt
- 2021 Measurement corrections invalid
- 2022 NV RAM write failure
- 2030-2089 A-D Correction Error (*Refer to Section 1.4.2 page 1-3*)

**2.6.5 Memory Tests**

**2.6.5.1 Non-volatile RAM Checksum Errors**

- 2100 Primary.
- 2101 Secondary.
- 2102 Input Zero.
- 2103 Frequency.

**2.6.5.2 Fuse Tests**

- 2111 Fuse is open circuit.  
(P084) +ve value OK

2.6.6 Reference Ratio Tests

Test Setup Model

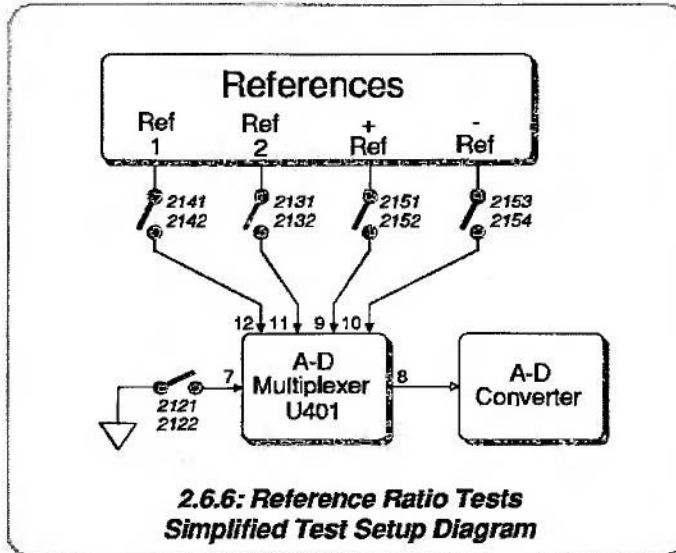

Volume 2 References

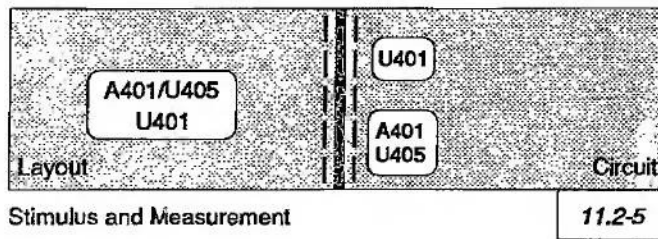



## List of Reference Ratio Tests

- 01 Ref Zero Checks**  
Input: Hard Zero to A-D Multiplexer. Measure: via A-D. No. of Readings: 1 Discarded; 6 Processed.
- 2121 Noise Standard Deviation  $\leq$  5ppm of FR  
2122 Magnitude  $| \text{Mean Ref zero} | \leq$  200ppm of FR
- P003 Ref 2 Checks**  
Input: Ref 2 to A-D Multiplexer. Measure: via A-D. No. of Readings: 1 Discarded; 6 Processed.
- 2131 Noise Standard Deviation  $\leq$  5ppm of FR  
2132 Magnitude  $-1.460 \leq \text{Mean Ref 2} \leq -1.340$
- P002 Ref 1 Checks**  
Input: Ref 1 to A-D Multiplexer. Measure: via A-D. No. of Readings: 1 Discarded; 6 Processed.
- 2141 Noise Standard Deviation  $\leq$  5ppm of FR  
2142 Magnitude  $-1.47492 \leq \text{Mean Ref 1} \leq -1.41708$
- Dig. Ref 1 : Ref 2 Magnitude Ratio Drift**  
Digital comparison of the present ratio against the ratio recorded at the most-recent Internal Source Cal.
- 2143 Ratio Drift  $-90\text{ppm} < \text{Ratio Drift} < +90\text{ppm}$
- P004 Positive Ref Checks**  
Input: +Ref to A-D Multiplexer. Measure: via A-D. No. of Readings: 4 Discarded; 8 Processed.
- 2151 Noise Standard Deviation  $\leq$  5ppm of FR  
2152 Magnitude  $+1.9992 < \text{Mean +Ref} < +2.0008$
- 005 Negative Ref Checks**  
Input: -Ref to A-D Multiplexer. Measure: via A-D. No. of Readings: 4 Discarded; 8 Processed.
- 2153 Noise Standard Deviation  $\leq$  5ppm of FR  
2154 Magnitude  $-2.0008 < \text{Mean -Ref} < -1.9992$
- Dig. +Ref 1 : -Ref 2 Magnitude Ratio**  
Digital calculation of +Ref : -Ref.
- 2155 Magnitude Ratio  $-1.0002 < +\text{Ref} / -\text{Ref} < -0.99998$
- Dig. +Ref 1 : -Ref 2 Magnitude Ratio Drift**  
Digital comparison of the present ratio against the ratio recorded at the most-recent Internal Source Cal.
- 2156 Ratio Drift  $-20\text{ppm} < \text{Ratio drift} < +20\text{ppm}$

## 2.6.7 DC Voltage Tests

### 2.6.7.1 True Zero Checks

#### Test Setup Model

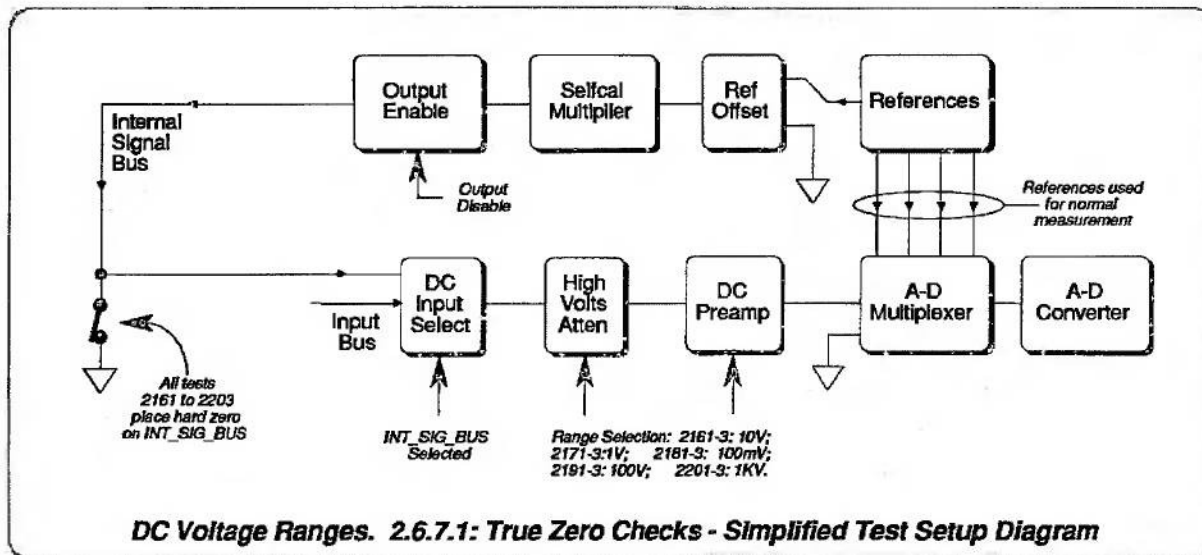

#### Volume 2 References

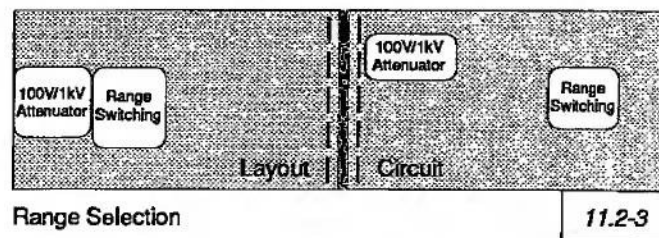
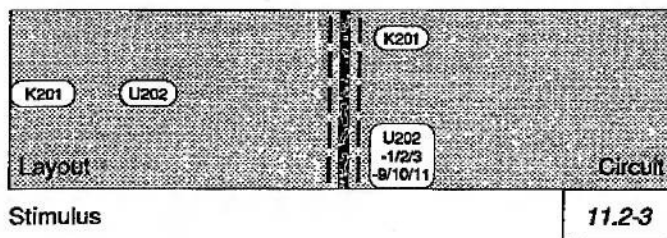

## List of True Zero Measurements

- 006 10V Range True Zero Checks**  
Input: Zero to 10VDC Range. Measure: via A-D. No of Readings: 4 Discarded; 16 Processed.
- 2161** Noise Standard Deviation  $\leq$  1ppm  
**2162** Magnitude  $-10\text{ppm} < \text{Mean } 10\text{V Zero} < +10\text{ppm}$
- Dig. 10V Range True Zero Magnitude Ratio Drift**  
Digital comparison of the present magnitude against that recorded at the most-recent Internal Source Cal.
- 2163** Zero Drift  $-4\text{ppm} < 10\text{V Zero Drift} < +4\text{ppm}$
- P011 1V Range True Zero Checks**  
Input: Zero to 1VDC Range. Measure: via A-D. No of Readings: 1 Discarded; 8 Processed.
- 2171** Noise Standard Deviation  $\leq$  2ppm  
**2172** Magnitude  $-25\text{ppm} < \text{Mean } 1\text{V Zero} < +25\text{ppm}$
- Dig. 1V Range True Zero Magnitude Ratio Drift**  
Digital comparison of the present magnitude against that recorded at the most-recent Internal Source Cal.
- 2173** Zero Drift  $-8\text{ppm} < 1\text{V Zero Drift} < +8\text{ppm}$
- P016 100mV Range True Zero Checks**  
Input: Zero to 100mVDC Range. Measure: via A-D. No of Readings: 1 Discarded; 8 Processed.
- 2181** Noise Standard Deviation  $\leq$  5ppm  
**2182** Magnitude  $-250\text{ppm} < \text{Mean } 100\text{mV Zero} < +250\text{ppm}$
- Dig. 100mV Range True Zero Magnitude Ratio Drift**  
Digital comparison of the present magnitude against that recorded at the most-recent Internal Source Cal.
- 2183** Zero Drift  $-40\text{ppm} < 100\text{mV Zero Drift} < +40\text{ppm}$
- P021 100V Range True Zero Checks**  
Input: Zero to 100VDC Range. Measure: via A-D. No of Readings: 1 Discarded; 8 Processed.
- 2191** Noise Standard Deviation  $\leq$  10ppm  
**2192** Magnitude  $-10\text{ppm} < \text{Mean } 100\text{V Zero} < +10\text{ppm}$
- Dig. 100V Range True Zero Magnitude Ratio Drift**  
Digital comparison of the present magnitude against that recorded at the most-recent Internal Source Cal.
- 2193** Zero Drift  $-8\text{ppm} < 100\text{V Zero Drift} < +8\text{ppm}$
- P028 1kV Range True Zero Checks**  
Input: Zero to 1kVDC Range. Measure: via A-D. No of Readings: 1 Discarded; 8 Processed.
- 2201** Noise Standard Deviation  $\leq$  10ppm  
**2202** Magnitude  $-10\text{ppm} < \text{Mean } 1\text{kV Zero} < +10\text{ppm}$
- Dig. 1kV Range True Zero Magnitude Ratio Drift**  
Digital comparison of the present magnitude against that recorded at the most-recent Internal Source Cal.
- 2203** Zero Drift  $-4\text{mV} < 1000\text{V Zero Drift} < +4\text{mV}$



Section 2 - Fault Diagnosis

2.6.7 DC Voltage Tests (Contd)

2.6.7.2 Negative Gain Measurements  
[Offset (Zero) and References]

Test Setup Model

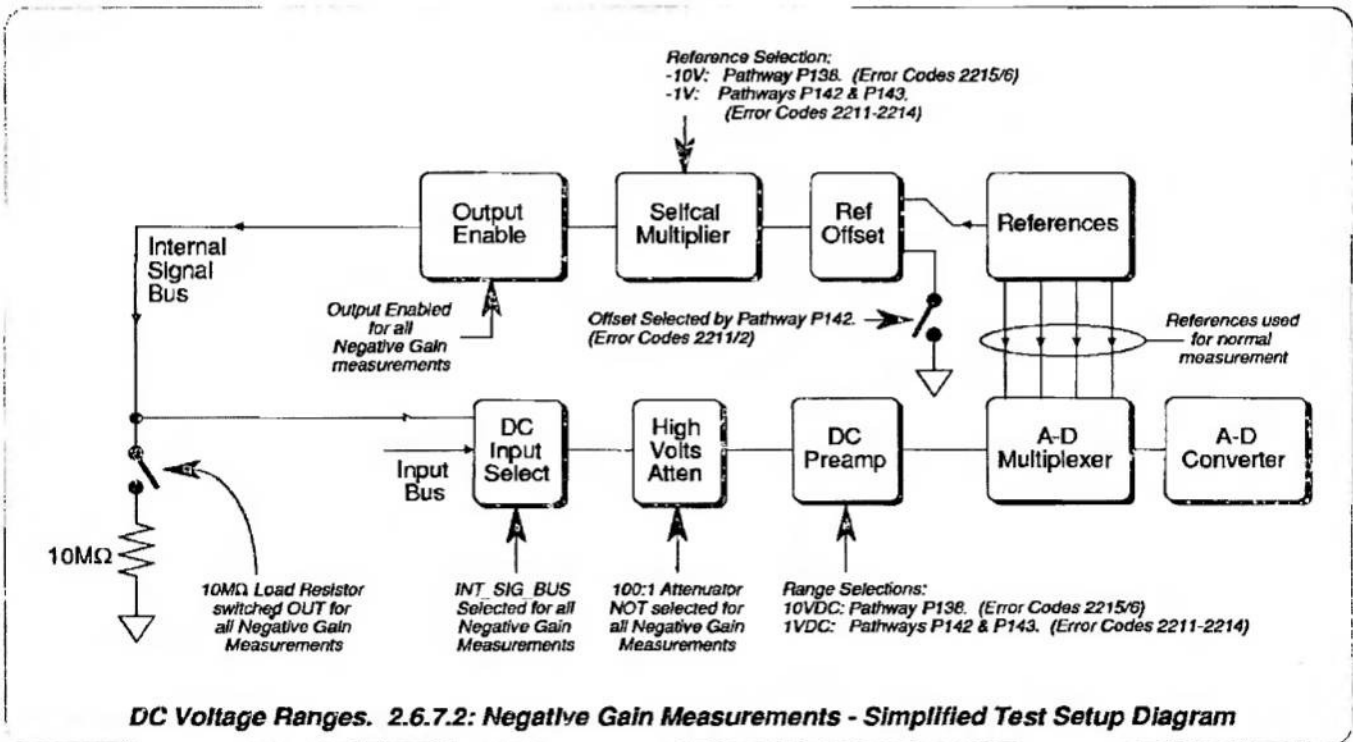

Volume 2 References

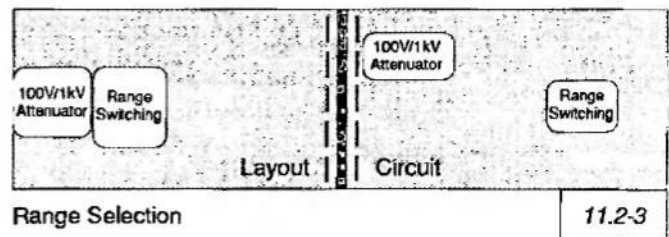
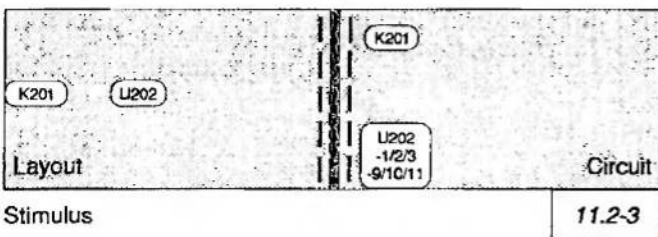

**List of Negative Gain Measurements****142 1V Range -Offset Zero Checks**

Input: -1V Offset to 1VDC Range. Measure: via A-D. No of Readings: 32 Discarded; 8 Processed.

- 2211 Noise Standard Deviation  $\leq 0.01$   
2212 Magnitude  $-2500\text{ppm} < \text{Mean } -1\text{V Offset} < +2500\text{ppm}$

**P143 1V Range -Reference Checks**

Input: -1V Reference to 1VDC Range. Measure: via A-D. No of Readings: 16 Discarded; 8 Processed.

- 2213 Noise Standard Deviation  $\leq 0.01$   
2214 Magnitude  $-1.040\text{V} < \text{Mean } 1\text{V Ref} < -0.960\text{V}$

**P138 10V Range -Reference Checks**

Input: -10V Reference to 10VDC Range. Measure: via A-D. No of Readings: 16 Discarded; 8 Processed.

- 2215 Noise Standard Deviation  $\leq 0.01$   
2216 Magnitude  $-10.2\text{V} < -10\text{V Ref} < -9.5\text{V}$

Section 2 - Fault Diagnosis

2.6.7 DC Voltage Tests (Contd)

2.6.7.3 Positive Gain Measurements  
[Offset (Zero) and References]

Test Setup Model

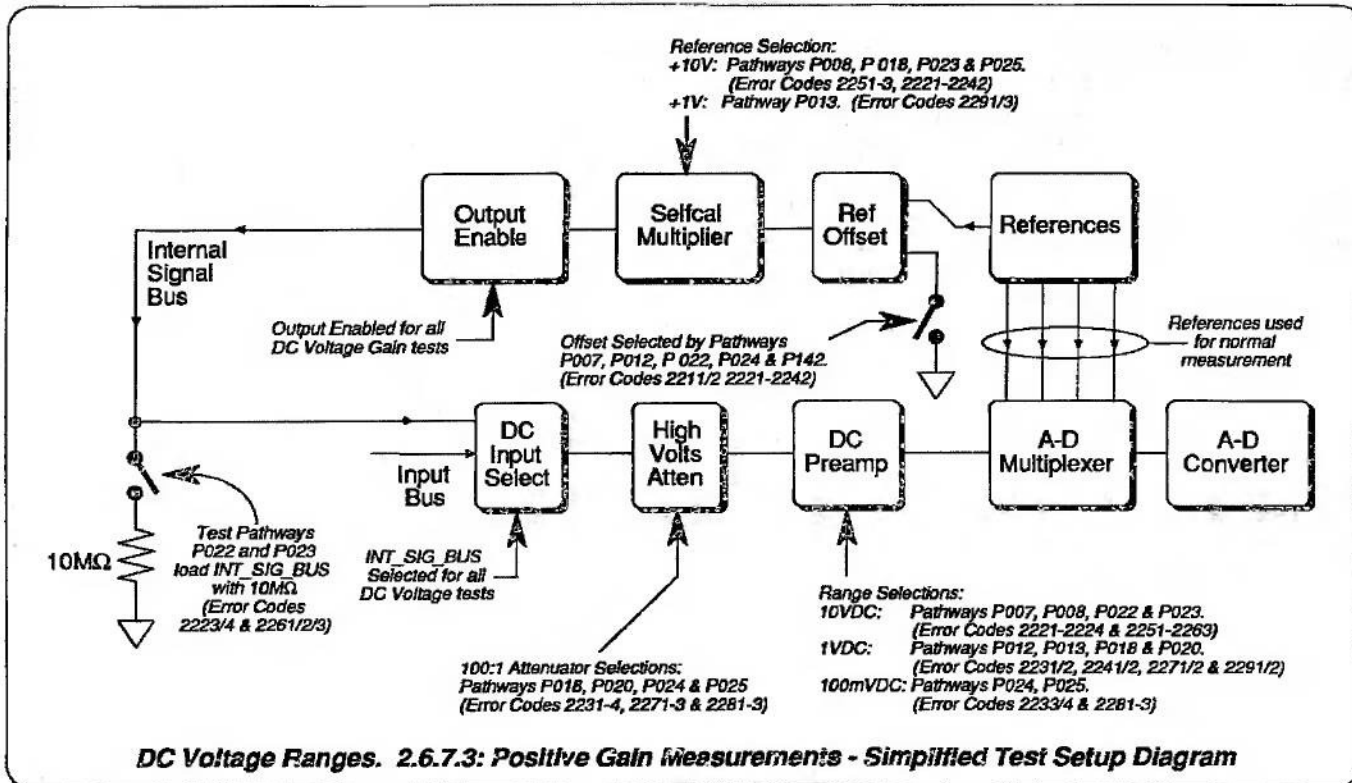

Volume 2 References

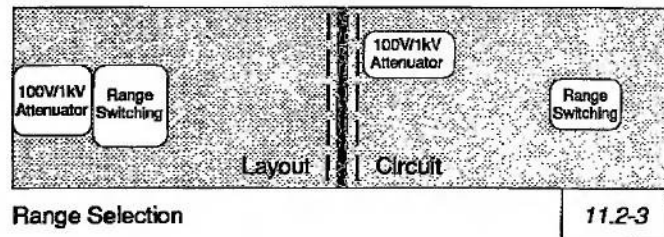
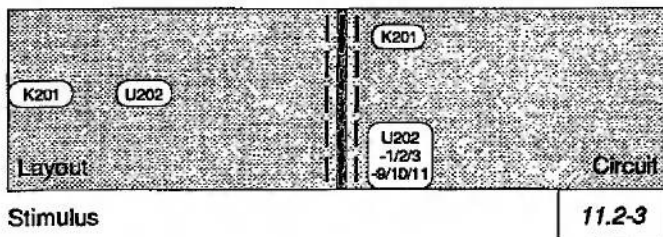



## List of Positive Gain Measurements

- 007 **10V Range +10V Offset Zero Checks**  
Input: +10V Offset to 10V DC Range. Measure: via A-D. No of Readings: 24 Discarded; 8 Processed.
- 2221 Noise Standard Deviation  $\leq$  2ppm  
2222 Magnitude  $-50\text{ppm} < \text{Mean} + 10\text{V Offset} < +50\text{ppm}$
- P022 **10V Range - Loaded +10V Offset Zero**  
Input: +10V Offset to 10M $\Omega$  Load and 10V DC Range. Measure: via A-D.  
No of Readings: 4 Discarded; 8 Processed.
- 2223 Noise Standard Deviation  $\leq$  2ppm  
2224 Offset Magnitude  $-50\text{ppm} < \text{Mean} + 10\text{V Offset} < +50\text{ppm}$
- P020 **1V Range - Attenuated +10V Offset Zero**  
Input: +10V Offset via attenuator to 1V DC Range. Measure: via A-D.  
No of Readings: 4 Discarded; 32 Processed.
- 2231 Noise Standard Deviation  $\leq$  2ppm  
2232 Magnitude  $-50\text{ppm} < \text{Mean} + 1\text{V Offset} < +50\text{ppm}$
- P024 **100mV Range - Attenuated +10V Offset Zero**  
Input: +10V Offset via attenuator to 100mV DC Range. Measure: via A-D.  
No of Readings: 4 Discarded; 16 Processed.
- 2233 Noise Standard Deviation  $\leq$  2ppm  
2234 Magnitude  $-500\text{ppm} < +100\text{mV Offset} < +500\text{ppm}$
- P012 **1V Range - +1V Offset Zero**  
Input: +1V Offset to 1V DC Range. Measure: via A-D. No of Readings: 8 Discarded; 12 Processed.
- 2241 Noise Standard Deviation  $\leq$  3ppm  
2242 Magnitude  $-500\text{ppm} < +\text{Offset} < +500\text{ppm}$
- P008 **10V Range - +Reference Checks**  
Input: +10V Reference to 10V DC Range. Measure: via A-D. No of Readings: 8 Discarded; 8 Processed.
- 2251 Noise Standard Deviation  $\leq$  2ppm  
2252 Magnitude  $+0.94 < +10\text{V Ref} < +1.01$
- Dig. **+10V Ref Magnitude Drift**  
Digital comparison of the present magnitude against that recorded at the most-recent Internal Source Cal.
- 2253 Magnitude Drift  $0.999940 < \text{drift} < 1.000060$
- P023 **10V Range - Loaded +10V Reference Checks**  
Input: +10V to 10M $\Omega$  Load and 10V DC Range. Measure: via A-D.  
No of Readings: 4 Discarded; 8 Processed.
- 2261 Noise Standard Deviation  $\leq$  3ppm  
2262 Magnitude  $+0.94 < 10\text{V Gain} < +1.01$
- Dig. **10V Range - Loaded +10V Ref Magnitude Drift**  
Digital comparison of the present magnitude against that recorded at the most-recent Internal Source Cal.
- 2263 Magnitude Drift  $0.999940 < \text{drift} < 1.000060$

Section 2 - Fault Diagnosis

2.6.7.3 Positive Gain Measurements (Contd)  
[Offset (Zero) and References]

Test Setup Model

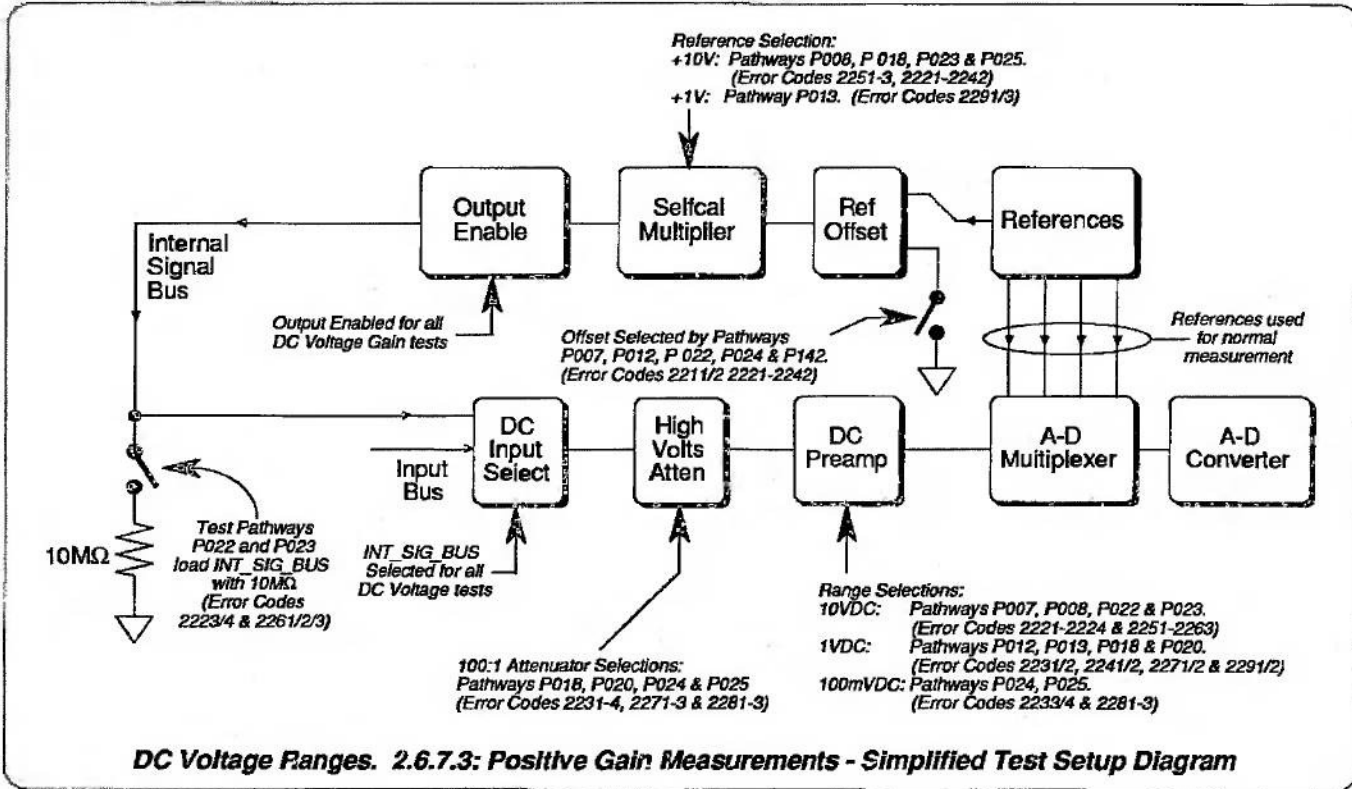

Volume 2 References

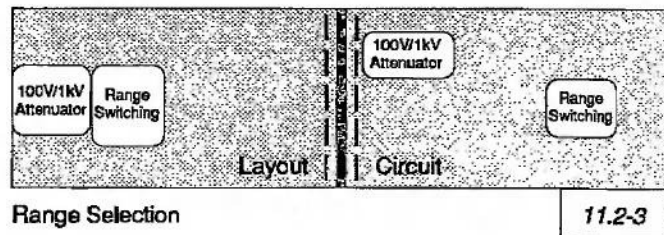
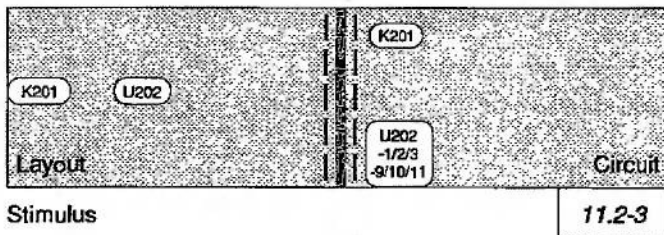

## List of Positive Gain Measurements (Contd.)

- 018 **1V Range - Attenuated +10V Reference Checks**  
 Input: +10V DC via 100:1 attenuator to 1V DC Range. Measure: via A-D.  
 No of Readings: 4 Discarded; 32 Processed.
- 2271 +100mV Signal Noise Standard Deviation of +100mV Signal  $\leq$  10ppm  
 2272 Magnitude  $+0.095 < +100\text{mV Signal Magnitude} < +0.101$
- Dig. **1V Range - Attenuated +10V Ref Magnitude Drift**  
 Digital comparison of the present magnitude against that recorded at the most-recent Internal Source Cal.
- 2273 +100mV Signal Mag. Drift  $+0.999910 < \text{drift} < +1.000090$
- P025 **100mV Range - Attenuated +10V Reference Checks**  
 Input: +10V DC via 100:1 attenuator to 100mV DC Range. Measure: via A-D.  
 No of Readings: 4 Discarded; 16 Processed.
- 2281 +100mV Signal Noise Standard Deviation of +100mV signal  $\leq$  10ppm  
 2282 Magnitude  $+0.94 < +100\text{mV Signal Magnitude} < +1.01$
- Dig. **100mV Range - Attenuated +10V Ref Magnitude Drift**  
 Digital comparison of the present magnitude against that recorded at the most-recent Internal Source Cal.
- 2283 +100mV Signal Mag. Drift  $+0.9999 < \text{drift} < +1.0001$
- P013 **1V Range - +1V Reference Checks**  
 Input: +1V Reference to 1V DC Range. Measure: via A-D. No of Readings: 8 Discarded; 12 Processed.
- 2291 Noise Standard Deviation  $\leq$  3ppm  
 2292 Magnitude  $+0.965 < +1\text{V Ref} < +1.025$
- Dig. **1V Range - +1V Ref Magnitude Drift**  
 Digital comparison of the present magnitude against that recorded at the most-recent Internal Source Cal.
- 2293 Drift  $+0.999940 < \text{Ref drift} < +1.000060$



Section 2 - Fault Diagnosis

2.6.8 AC Voltage Tests

2.6.8.1 Positive Tests

Test Setup Model

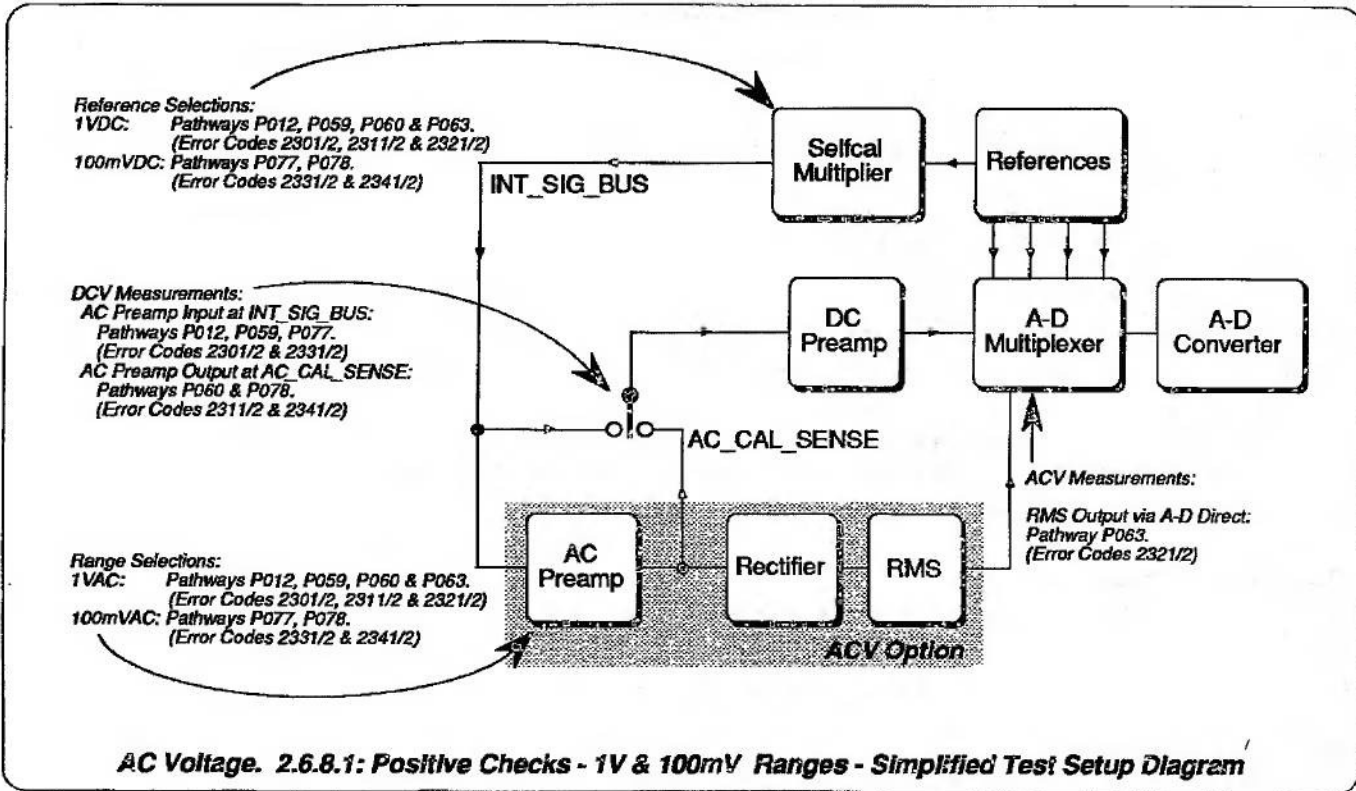

Volume 2 References

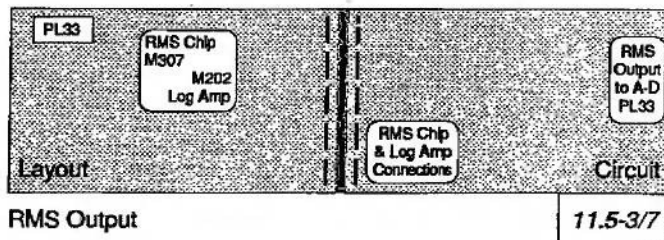
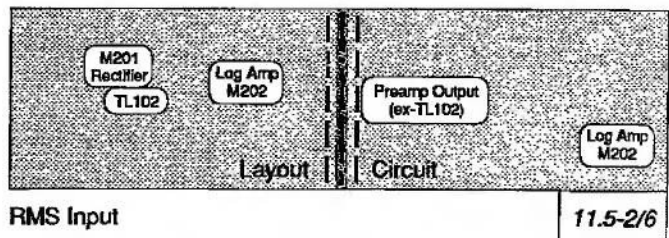
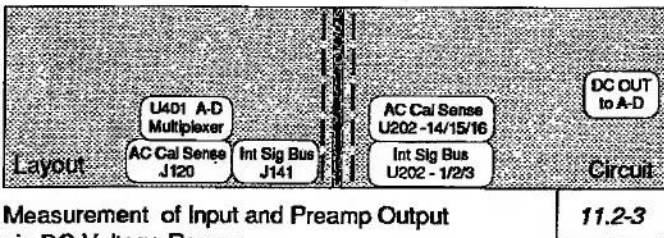
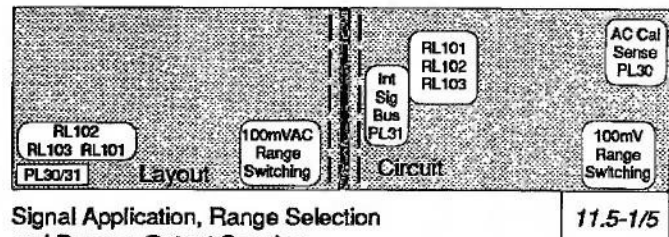
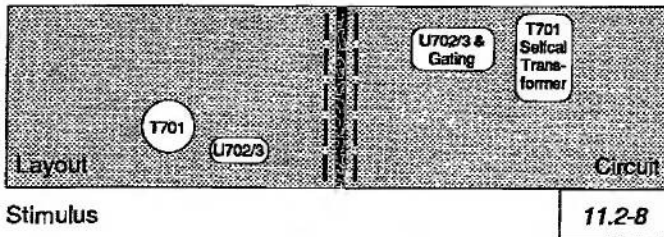

## List of Positive Measurements

## AC Range

- P012 1V AC Range - Settling Time**  
 Input: +1VDC to AC Preamp set to 1VAC Range. Measure: Input using 1V DC Range at INT\_SIG\_BUS.  
 No. of Readings: 0 Discarded; 8 Processed then Discarded to generate settling time.  
 Measure and Discard — (settling)
- P059 1V AC Range - +1V DC Input Checks**  
 Input: +1VDC to AC Preamp set to 1VAC Range. Measure: Input using 1V DC Range at INT\_SIG\_BUS.  
 No. of Readings: 8 Discarded; 8 Processed.
- 2301** Input Noise                      Standard Deviation  $\leq$  20ppm of FS  
**2302** Input Magnitude                 $+0.96 < \text{Mean Signal} < +1.04$
- P060 1V AC Range - +1V DC input - Checks at AC Preamp Output**  
 Input: +1VDC to AC Preamp set to 1VAC Range.  
 Measure: Preamp Output using 1V DC Range at AC\_CAL\_SENSE.  
 No. of Readings: 2 Discarded; 16 Processed.
- 2311** Preamp Output Noise            Standard Deviation  $\leq$  50ppm of FS  
**2312** Preamp Output Magnitude     $-1.04 < \text{Mean Signal} < -0.96$
- P063 1V AC Range - +1V DC Input - Checks at RMS Converter Output**  
 Input: +1VDC to AC Preamp set to 1VAC Range. Measure: RMS Output via A-D.  
 No. of Readings: 2 Discarded; 16 Processed.
- 2321** +RMS Output Noise            Standard Deviation  $\leq$  50ppm of FS  
**2322** +RMS Output Magnitude       $+0.96 < \text{Mean Signal} < +1.04$

## 100mV AC Range

- P077 100mV AC Range - +100mV DC Input Checks**  
 Input: +100mVDC to AC Preamp set to 100mVAC Range.  
 Measure: Input using 100mV DC Range at INT\_SIG\_BUS.  
 No. of Readings: 8 Discarded; 8 Processed.
- 2331** Input Noise                      Standard Deviation  $\leq$  20ppm of FS  
**2332** Input Magnitude                 $+1.70 < \text{Mean Signal} < +2.00$
- P078 100mV AC Range - +100mV DC input - Checks at AC Preamp Output**  
 Input: +100mVDC to AC Preamp set to 100mVAC Range.  
 Measure: Preamp Output using 1V DC Range at AC\_CAL\_SENSE.  
 No. of Readings: 2 Discarded; 32 Processed.
- 2341** Preamp Output Noise            Standard Deviation  $\leq$  50ppm of FS  
**2342** Preamp Output Magnitude     $-2.00 < \text{Mean Signal} < -1.70$



Section 2 - Fault Diagnosis

2.6.8.1 Positive Tests (Contd.)

Test Setup Model

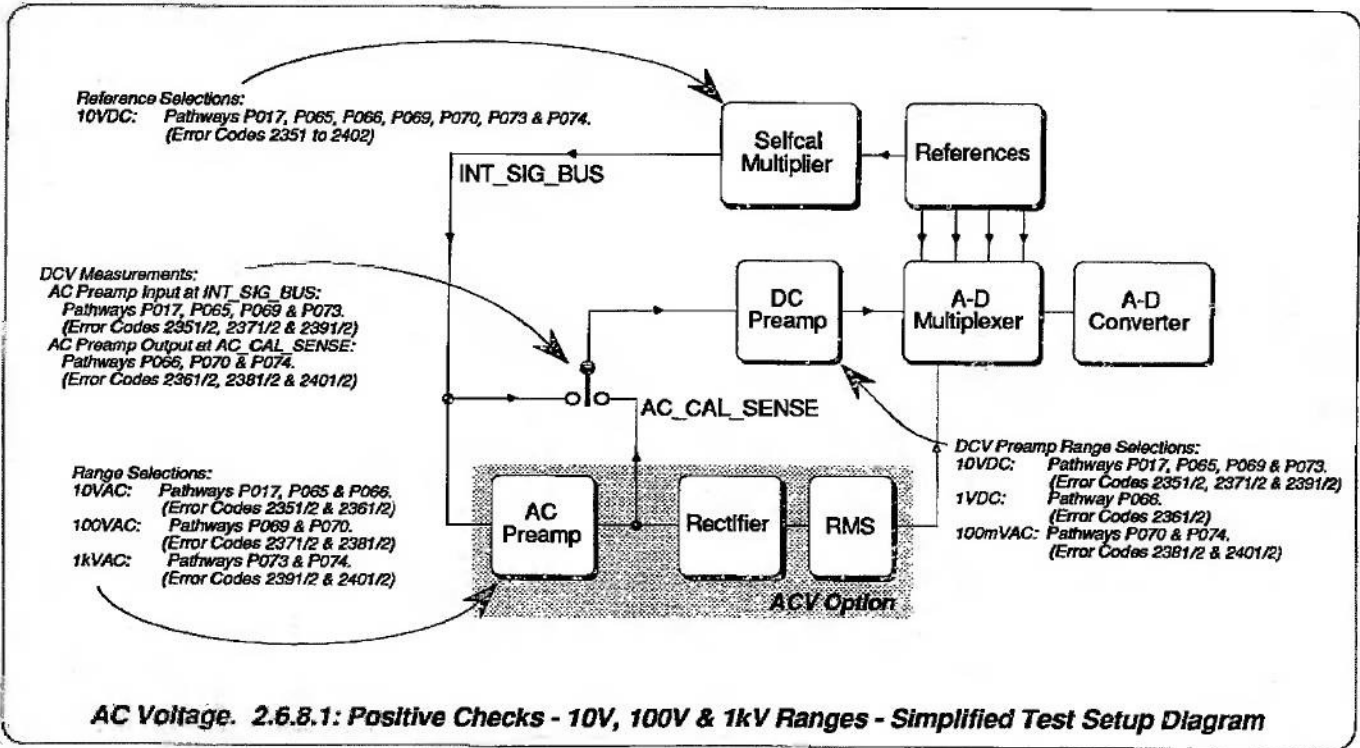

Volume 2 References

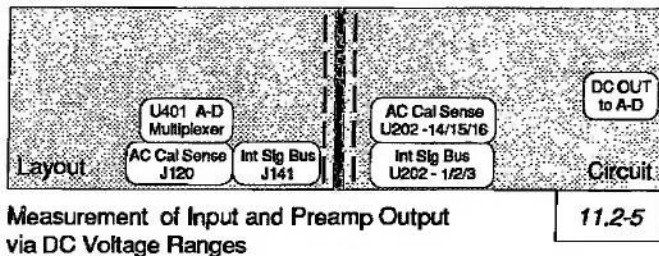
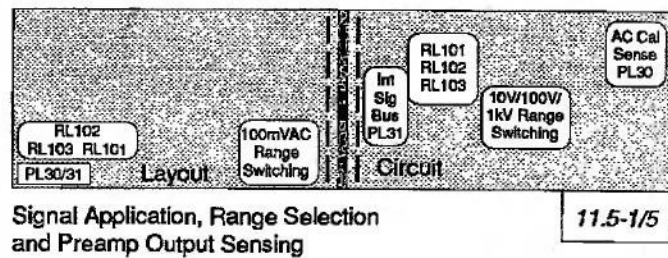
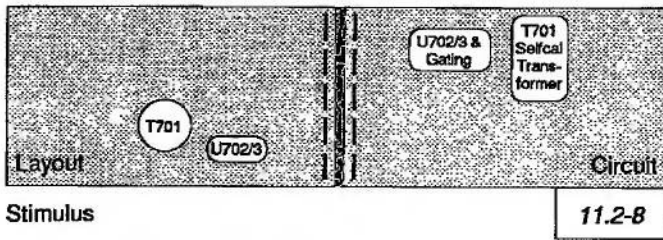



## List of Positive Measurements (Contd.)

## V AC Range

- P017 10V AC Range - Settling Time**  
 Input: +10VDC to AC Preamp set to 10VAC Range.  
 Measure: Input using 10V DC Range at INT\_SIG\_BUS.  
 No. of Readings: 0 Discarded; 8 Processed then Discarded to generate settling time.  
 Measure and Discard — (settling)
- P065 10V AC Range - +10V DC Input Checks**  
 Input: +10VDC to AC Preamp set to 10VAC Range. Measure: Input using 10V DC Range at INT\_SIG\_BUS.  
 No. of Readings: 8 Discarded; 8 Processed.
- 2351** Input Noise Standard Deviation  $\leq$  20ppm of FS  
**2352** Input Magnitude  $+0.94 < \text{Mean Signal} < +1.02$
- P066 10V AC Range - +10V DC Input - Checks at AC Preamp Output**  
 Input: +10VDC to AC Preamp set to 10VAC Range.  
 Measure: Preamp Output using 1V DC Range at AC\_CAL\_SENSE.  
 No. of Readings: 2 Discarded; 8 Processed.
- 2361** Preamp Output Noise Standard Deviation  $\leq$  50ppm of FS  
**2362** Preamp Output Magnitude  $-1.02 < \text{Mean Signal} < -0.95$

## 100V AC Range

- P069 100V AC Range - +10V DC Input Checks**  
 Input: +10VDC to AC Preamp set to 100VAC Range. Measure: Input using 10V DC Range at INT\_SIG\_BUS.  
 No. of Readings: 8 Discarded; 8 Processed.
- 2371** Input Noise Standard Deviation  $\leq$  20ppm of FS  
**2372** Input Magnitude  $+0.94 < \text{Mean Signal} < +1.02$
- P070 100V AC Range - +10V DC Input - Checks at AC Preamp Output**  
 Input: +10VDC to AC Preamp set to 100VAC Range.  
 Measure: Preamp Output using 100mV DC Range at AC\_CAL\_SENSE.  
 No. of Readings: 2 Discarded; 16 Processed.
- 2381** Preamp Output Noise Standard Deviation  $\leq$  50ppm of FS  
**2382** Preamp Output Magnitude  $-1.02 < \text{Mean Signal} < -0.94$

## 1kV AC Range

- P073 1kV AC Range - +10V DC Input Checks**  
 Input: +10VDC to AC Preamp set to 1kVAC Range. Measure: Input using 10V DC Range at INT\_SIG\_BUS.  
 No. of Readings: 8 Discarded; 8 Processed.
- 2391** Input Noise Standard Deviation  $\leq$  20ppm of FS  
**2392** Input Magnitude  $+0.94 < \text{Mean Signal} < +1.02$
- P074 1kV AC Range - +10V DC input - Checks at AC Preamp Output**  
 Input: +10VDC to AC Preamp set to 1kVAC Range.  
 Measure: Preamp Output using 100mV DC Range at AC\_CAL\_SENSE.  
 No. of Readings: 2 Discarded; 16 Processed.
- 2401** Preamp Output Noise Standard Deviation  $\leq$  50ppm of FS  
**2402** Preamp Output Magnitude  $-0.2017596 < \text{Mean Signal} < -0.1862397$

Section 2 - Fault Diagnosis

2.6.8 AC Voltage Tests (Contd.)

2.6.8.2 Negative Tests

Test Setup Model

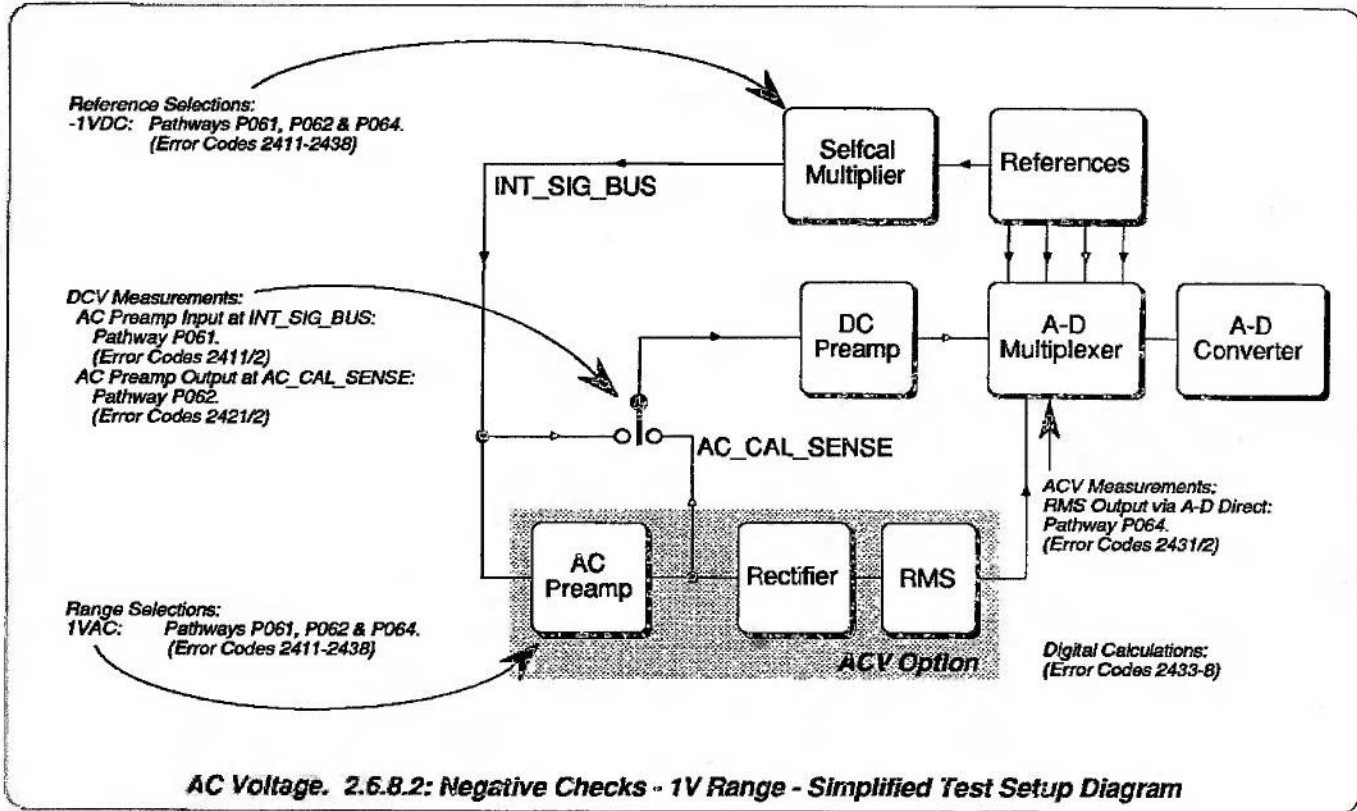

Volume 2 References

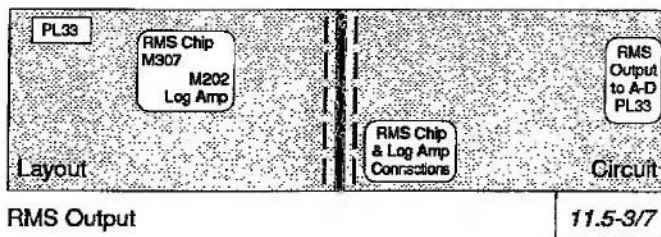
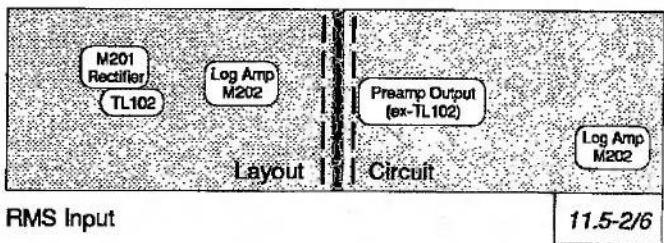
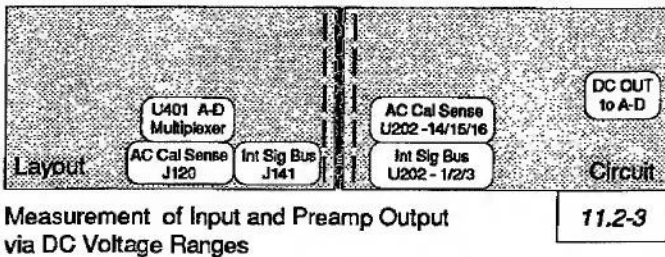
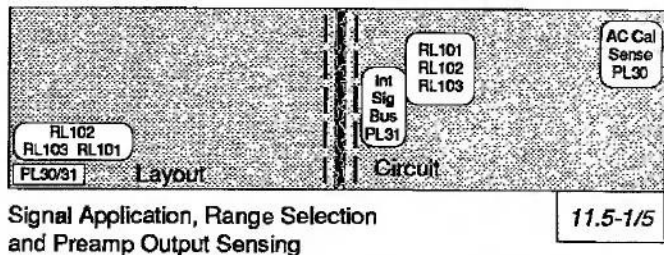
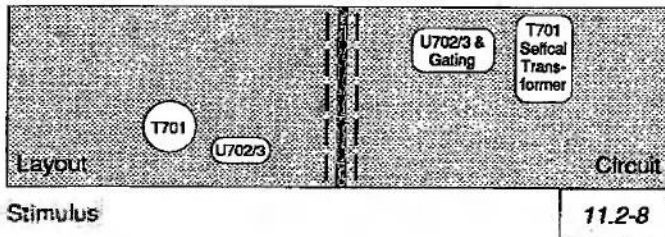



## List of Negative Measurements

## 1V AC Range

## P061 1V AC Range - Settling Time

Input: -1VDC to AC Preamp set to 1VAC Range. Measure: Input using 1V DC Range at INT\_SIG\_BUS.  
No. of Readings: 24 Discarded; 8 Processed then Discarded to generate settling time.

Measure and Discard — (settling)

## P061 1V AC Range - -1V DC Input Checks

Input: -1VDC to AC Preamp set to 1VAC Range. Measure: Input using 1V DC Range at INT\_SIG\_BUS.  
No. of Readings: 8 Discarded; 8 Processed.

2411 Input Noise Standard Deviation  $\leq$  20ppm of FS

2412 Input Magnitude  $-1.04 < \text{Mean Signal} < -0.96$

## P062 1V AC Range - -1V DC input - Checks at AC Preamp Output

Input: -1VDC to AC Preamp set to 1VAC Range.  
Measure: Preamp Output using 1V DC Range at AC\_CAL\_SENSE.  
No. of Readings: 2 Discarded; 16 Processed.

2421 Preamp Output Noise Standard Deviation  $\leq$  50ppm of FS

2422 Preamp Output Magnitude  $+0.96V < \text{Mean Signal} < +1.04V$

## P064 1V AC Range - -1V DC input - Checks at RMS Converter Output

Input: -1VDC to AC Preamp set to 1VAC Range. Measure: RMS Output via A-D.  
No. of Readings: 2 Discarded; 16 Processed.

2431 RMS Output Noise Standard Deviation  $\leq$  50ppm of FS

2432 -RMS Output Magnitude  $0.96 < \text{Mean Signal} < 1.04$

## Dig. RMS Converter Mean 1V Offset

Digital Calculation: Mean of RMS +1V offset and -1V offset.

2433 1V Offset Magnitude  $-100\text{ppm of FS} < \text{Mean Offset} < +100\text{ppm of FS}$

## Dig. 1V AC Range - Preamp Gain Drift

Digital Comparison of the present Gain against its value recorded at the most-recent internal Source Cal.

2434 Preamp Gain Drift  $0.999650 < \text{Drift Ratio} < 1.000350$

## Dig. +RMS Gain

Digital Calculation of the present RMS Converter +Gain.

2435 +RMS Gain  $+0.94 < +\text{RMS Gain} < +1.05$

## Dig. +RMS Gain Drift

Digital Comparison of the present +RMS Gain against its value recorded at the most-recent Internal Source Cal.

2436 +RMS Gain Drift Ratio  $0.999300 < \text{Drift Ratio} < 1.000700$

## Dig. -RMS Gain

Digital Calculation of the present RMS Converter -Gain.

2437 -RMS Gain  $-1.06 < -\text{RMS Gain} < -0.95$

## Dig. -RMS Gain Drift

Digital Comparison of the present -RMS Gain against its value recorded at the most-recent Internal Source Cal.

2438 -RMS Gain Drift Ratio  $0.999300 < \text{Drift Ratio} < 1.000700$



Section 2 - Fault Diagnosis

2.6.8.2 Negative Tests (Contd.)

Test Setup Model

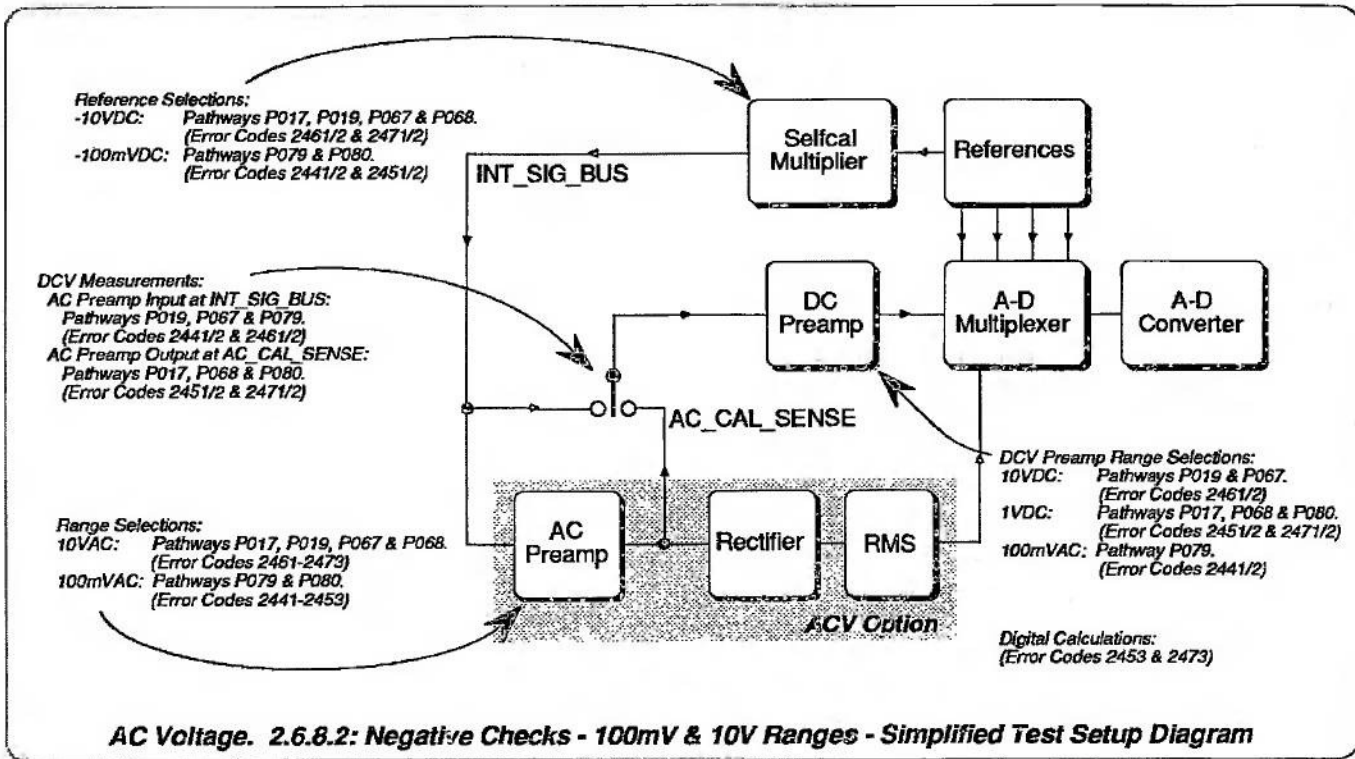

Volume 2 References

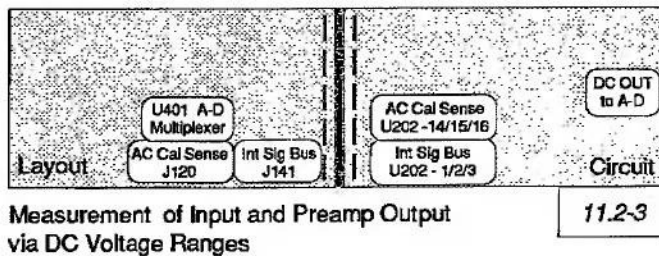
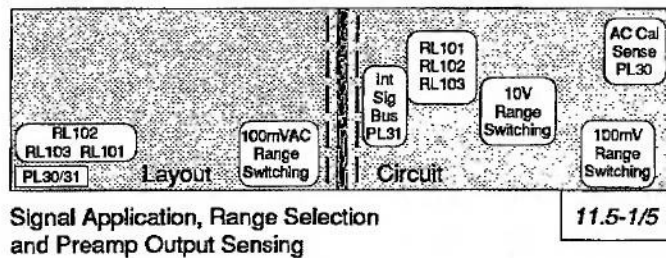
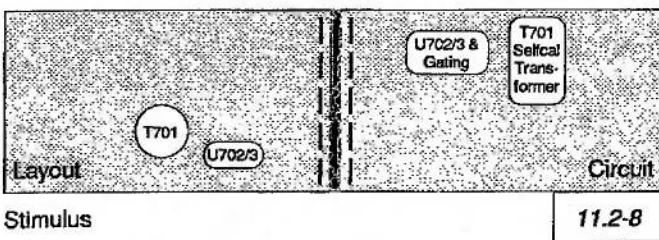

## List of Negative Measurements (Contd.)

## 100mV AC Range

## P079 100mV AC Range - -100mV DC Input Checks

Input: -100mVDC to AC Preamp set to 100mVAC Range.  
 Measure: Input using 100mV DC Range at INT\_SIG\_BUS.  
 No. of Readings: 8 Discarded; 8 Processed.

2441 Input Noise Standard Deviation  $\leq$  20ppm of FS  
 2442 Input Magnitude  $-2.00 < \text{Mean Signal} < -1.70$

## P080 100mV AC Range - -100mV DC Input - Checks at AC Preamp Output

Input: -100mVDC to AC Preamp set to 100mVAC Range.  
 Measure: Preamp Output using 1V DC Range at AC\_CAL\_SENSE.  
 No. of Readings: 2 Discarded; 32 Processed.

2451 Preamp Output Noise Standard Deviation  $\leq$  50ppm of FS  
 2452 Preamp Output Magnitude  $+1.70 < \text{Mean Signal} < +2.00$

## Dig. 100mV AC Range - Preamp Gain Drift

Digital Comparison of the present Gain against its value recorded at the most-recent Internal Source Cal.

2453 Preamp Gain Drift  $0.999650 < \text{Drift Ratio} < 1.000350$

## 10V AC Range

## P019 10V AC Range - Settling Time

Input: -10VDC to AC Preamp set to 10VAC Range. Measure: Input using 10V DC Range at INT\_SIG\_BUS.  
 No. of Readings: 0 Discarded; 8 Processed.  
 Measure and Discard — (Settling)

## P067 10V AC Range - -10V DC Input Checks

Input: -10VDC to AC Preamp set to 10VAC Range. Measure: Input using 10V DC Range at INT\_SIG\_BUS.  
 No. of Readings: 8 Discarded; 8 Processed.

2461 Input Noise Standard Deviation  $\leq$  20ppm of FS  
 2462 Input Magnitude  $-1.02 < \text{Mean Signal} < -0.94$

## P068 10V AC Range - -10V DC Input - Checks at AC Preamp Output

Input: -10VDC to AC Preamp set to 10VAC Range.  
 Measure: Preamp Output using 1V DC Range at AC\_CAL\_SENSE.  
 No. of Readings: 2 Discarded; 8 Processed.

2471 Preamp Output Noise Standard Deviation  $\leq$  50ppm of FS  
 2472 Preamp Output Magnitude  $+0.94 < \text{Mean Signal} < +1.02$

## Dig. 10V AC Range - Preamp Gain Drift

Digital Comparison of the present Gain against its value recorded at the most-recent Internal Source Cal.

2473 Preamp Gain Drift  $0.999650 < \text{Drift Ratio} < 1.000350$



Section 2 - Fault Diagnosis

2.6.8.2 Negative Tests (Contd.)

Test Setup Model

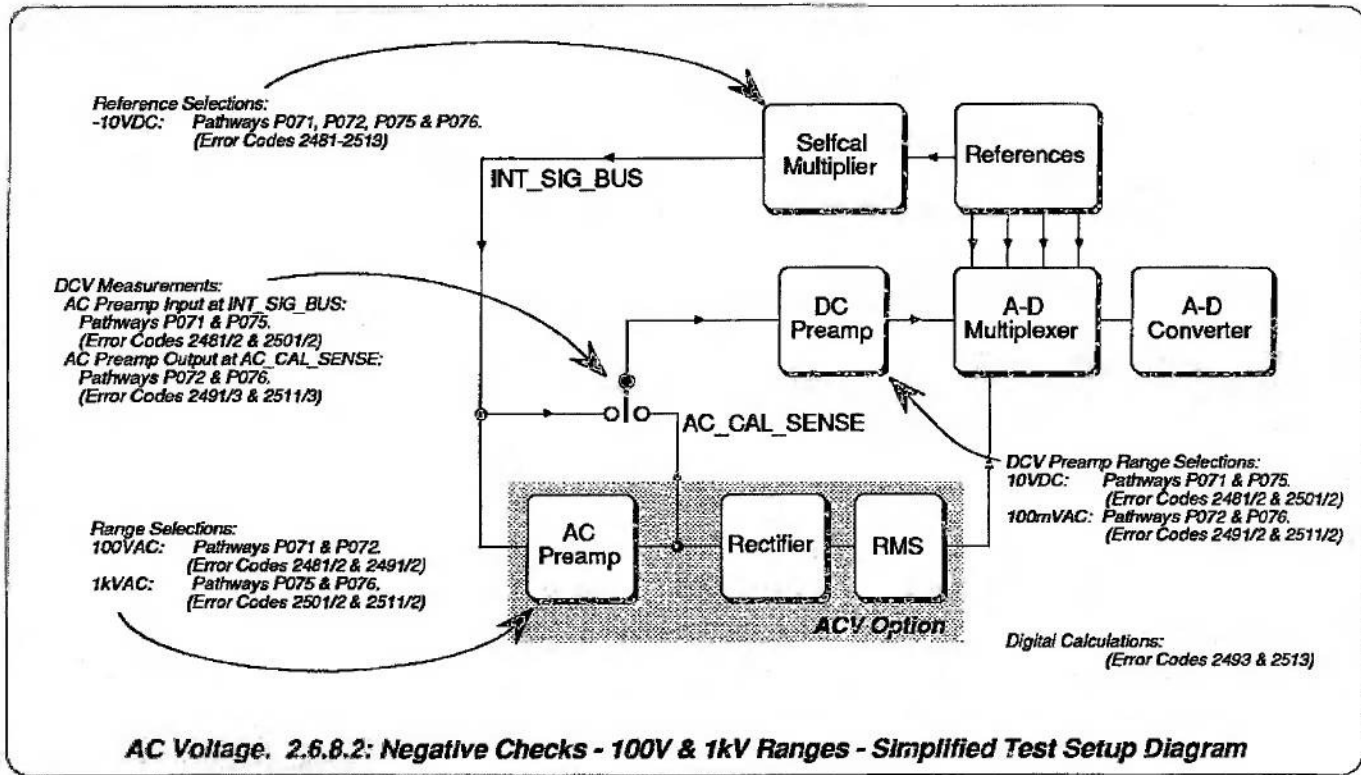

Volume 2 References

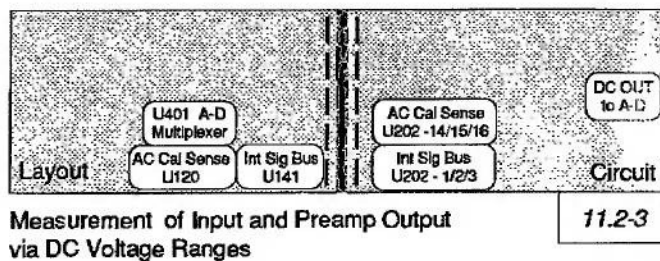
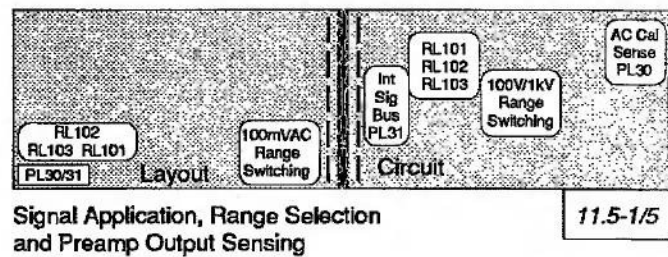
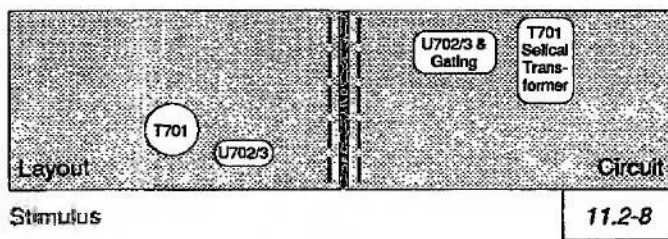



## List of Negative Measurements (Contd.)

## 10V AC Range

- P071 100V AC Range - -10V DC Input Checks**  
 Input: -10VDC to AC Preamp set to 100VAC Range. Measure: Input using 10V DC Range at INT\_SIG\_BUS.  
 No. of Readings: 8 Discarded; 8 Processed.
- 2481** Input Noise                      Standard Deviation  $\leq$  20ppm of FS
- 2482** Input Magnitude                 $-1.02 < \text{Mean Signal} < -0.94$
- P072 100V AC Range - -10V DC Input - Checks at AC Preamp Output**  
 Input: -10VDC to AC Preamp set to 100VAC Range.  
 Measure: Preamp Output using 100mV DC Range at AC\_CAL\_SENSE.  
 No. of Readings: 2 Discarded; 16 Processed.
- 2491** Preamp Output Noise            Standard Deviation  $\leq$  50ppm of FS
- 2492** Preamp Output Magnitude     $+0.94 < \text{Mean Signal} < +1.02$
- Dig. 100V AC Range - Preamp Gain Drift**  
 Digital Comparison of the present Gain against its value recorded at the most-recent Internal Source Cal.
- 2493** Preamp Gain Drift                 $0.999650 < \text{Drift Ratio} < 1.000350$

## 1000V AC Range

- P075 1kV AC Range - -10V DC Input Checks**  
 Input: -10VDC to AC Preamp set to 1kVAC Range. Measure: Input using 10V DC Range at INT\_SIG\_BUS.  
 No. of Readings: 8 Discarded; 8 Processed.
- 2501** Input Noise                      Standard Deviation  $\leq$  20ppm of FS
- 2502** Input Magnitude                 $-1.02 < \text{Mean Signal} < -0.94$
- P076 1kV AC Range - -10V DC Input - Checks at AC Preamp Output**  
 Input: -10VDC to AC Preamp set to 1kVAC Range.  
 Measure: Preamp Output using 100mV DC Range at AC\_CAL\_SENSE.  
 No. of Readings: 2 Discarded; 16 Processed.
- 2511** Preamp Output Noise            Standard Deviation  $\leq$  50ppm of FS
- 2512** Preamp Output Magnitude     $+0.1862397 < \text{Mean Signal} < +0.2017596$
- Dig. 1kV AC Range - Preamp Gain Drift**  
 Digital Comparison of the present Gain against its value recorded at the most-recent Internal Source Cal.
- 2513** Preamp Gain Drift                 $0.999650 < \text{Drift Ratio} < 1.000350$

## 2.6.9 DC Current Tests

### Test Setup Models

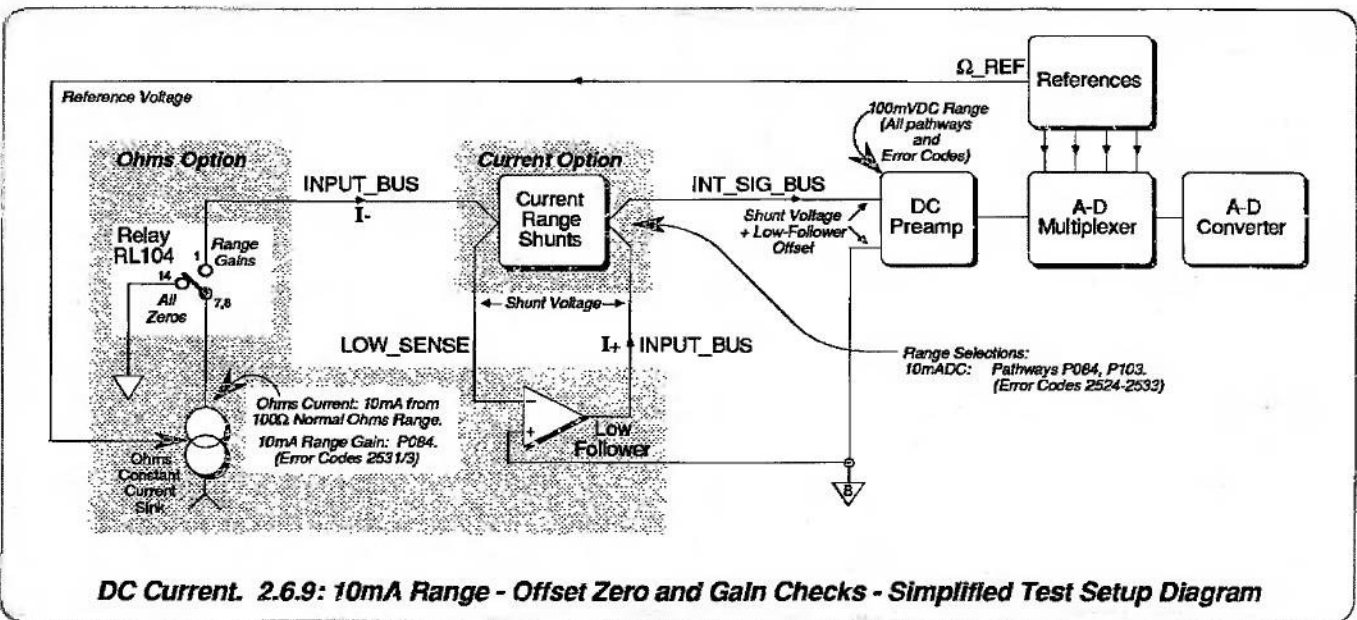
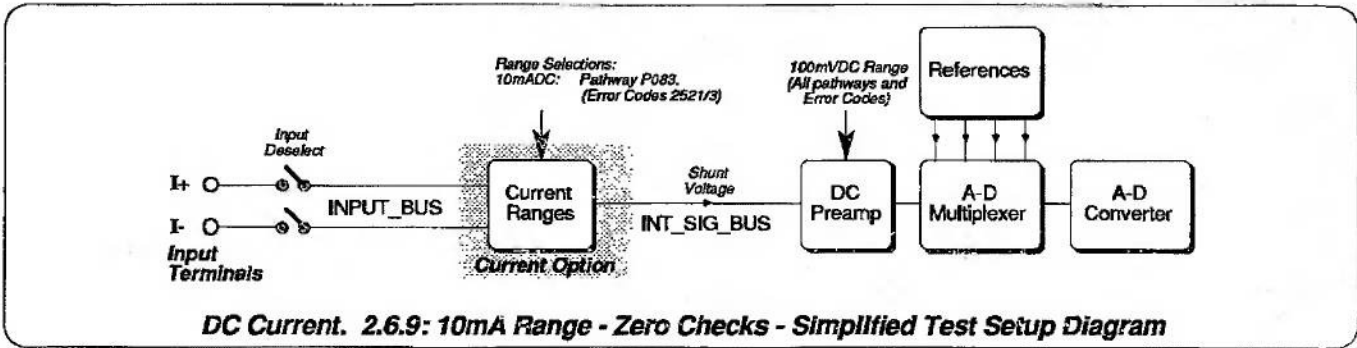

### Volume 2 References

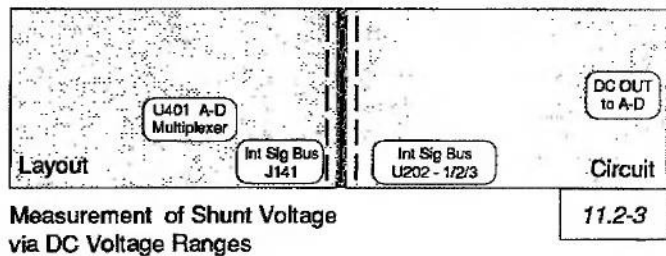
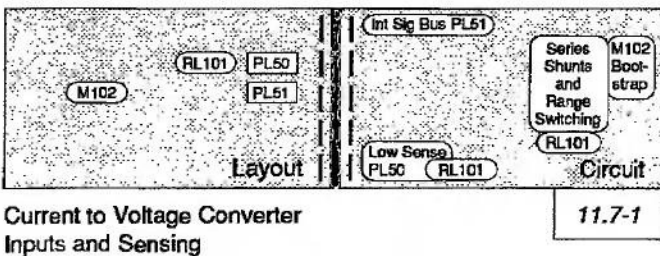
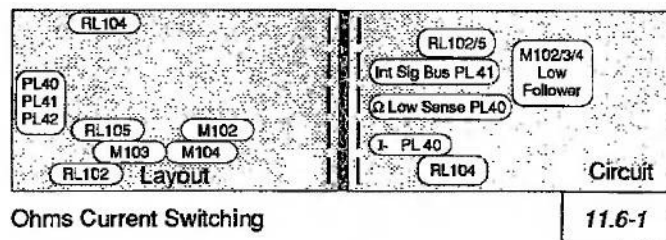
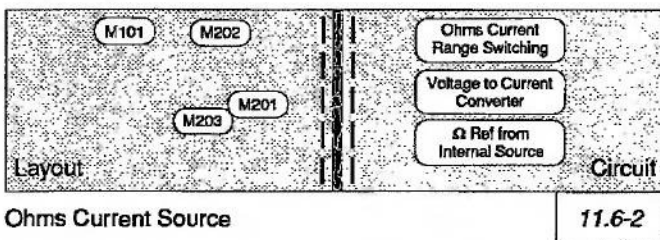



## List of DC Current Measurements

## 10mA DC Range

## P083 10mA Range True Zero Checks

Ohms Current: Deselected. Input Bus: Inputs deselected.  
 Measure: 10mA DC Range via INT\_SIG\_BUS, 100mV DC Range and A-D.  
 No. of Readings: 4 Discarded; 8 Processed.

2521 Noise Standard Deviation  $\leq$  10ppm of FS  
 2522 Magnitude  $-100\text{ppm of FS} < \text{Mean Magnitude} < +100\text{ppm of FS}$

## Dig. 10mA Range True Zero Magnitude Drift

Digital comparison of the present magnitude against that recorded at the most-recent Internal Source Cal.

2523 Zero Drift  $-35\text{ppm of FS} < \text{Drift} < +35\text{ppm of FS}$

## P103 10mA Range - Ohms Low-Follower Zero Offset Checks

All inputs deselected. Selfcal Current open circuit.  
 Measure: 10mA DC Range Shunt using 100 $\Omega$  Normal Ohms Range (Zero Offset only).  
 No. of Readings: 4 Discarded; 16 Processed.

2524 Zero Offset Noise Standard Deviation  $\leq$  10ppm of FS  
 2525 Zero Offset Magnitude  $-100\text{ppm of FS} < \text{Mean Magnitude} < +100\text{ppm of FS}$

## P084 10mA Range - Gain Checks

Inputs: 10mA Ohms Current via LOW\_SENSE; 10mA Selfcal Current Selected.  
 Measure: 10mA DC Range Shunt value using 100 $\Omega$  Normal Ohms Range.  
 No. of Readings: 8 Discarded; 8 Processed.

2531 Range Gain Noise Standard Deviation  $\leq$  10ppm of FS  
 2532 Range Gain Magnitude  $+0.98 < \text{Mean Magnitude} < +1.02$

## Dig. 10mA DC Range Gain Magnitude Drift

Digital comparison of the present magnitude against that recorded at the most-recent Internal Source Cal.

2533 Magnitude Drift  $+0.999690 < \text{Drift Ratio} < +1.000310$



Section 2 - Fault Diagnosis

2.6.9 DC Current Tests (Contd.)

Test Setup Models

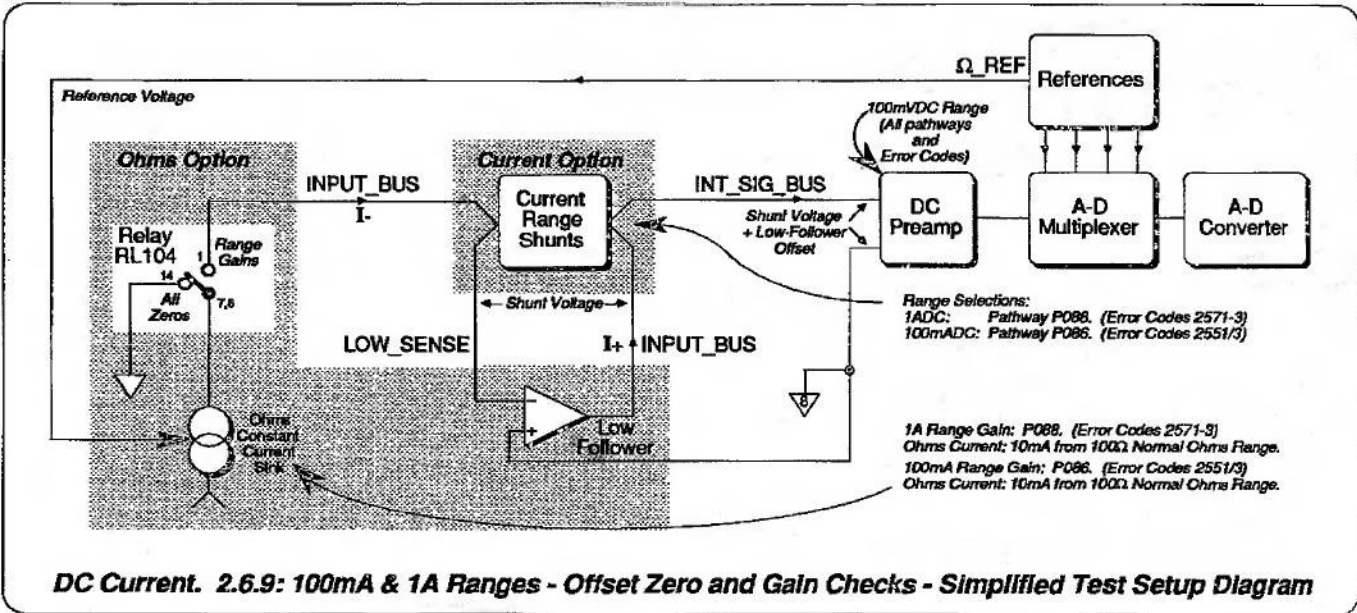
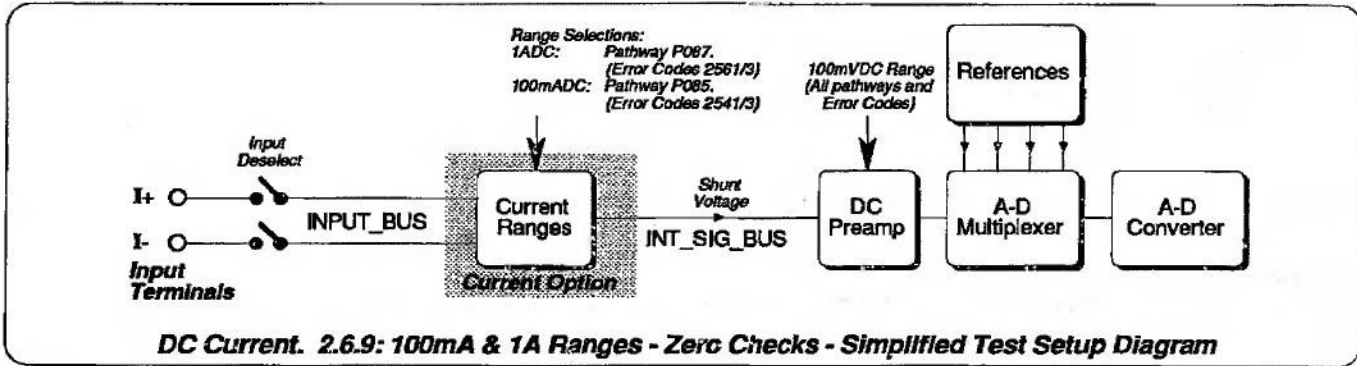

Volume 2 References

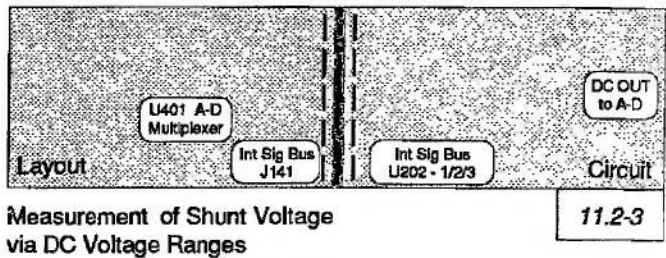
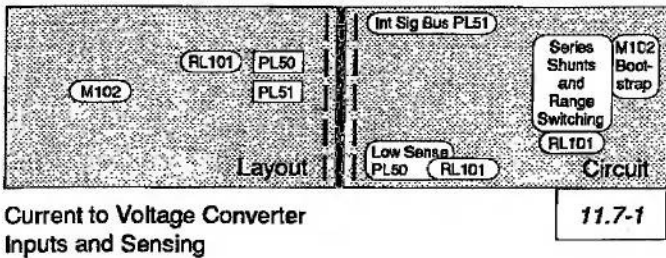
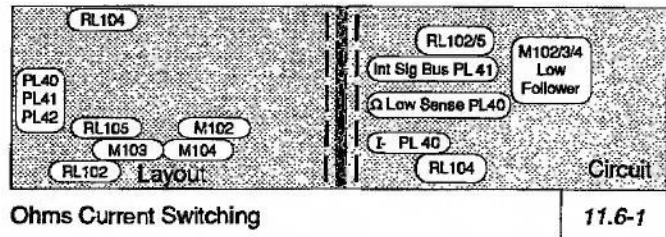
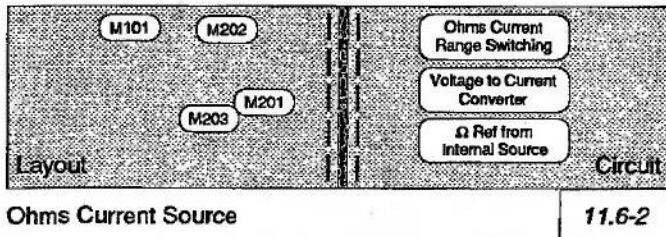

## List of DC Current Measurements (Contd.)

## 100mA DC Range

## P085 100mA Range True Zero Checks

Ohms Current: Deselected. Input Bus: Inputs deselected.  
Measure: 100mA DC Range via INT\_SIG\_BUS, 100mV DC Range and A-D.  
No. of Readings: 4 Discarded; 16 Processed.

- 2541 Noise Standard Deviation  $\leq$  10ppm of FS  
2542 Magnitude  $-100\text{ppm of FS} < \text{Mean Magnitude} < +100\text{ppm of FS}$

## Dig. 100mA Range True Zero Magnitude Drift

Digital comparison of the present magnitude against that recorded at the most-recent Internal Source Cal.

- 2543 Zero Drift  $-35\text{ppm of FS} < \text{Drift} < +35\text{ppm of FS}$

## P086 100mA Range - Gain Checks

Inputs: 10mA Ohms Current via LOW\_SENSE; 100mA Selfcal Current Selected.  
Measure: 100mA DC Range Shunt value using 100 $\Omega$  Normal Ohms Range.  
No. of Readings: 4 Discarded; 16 Processed.

- 2551 Range Gain Noise Standard Deviation  $\leq$  10ppm of FS  
2552 Range Gain Magnitude  $+0.098 < \text{Mean Magnitude} < +0.102$

## Dig. 100mA DC Range Gain Magnitude Drift

Digital comparison of the present magnitude against that recorded at the most-recent Internal Source Cal.

- 2553 Magnitude Drift  $+0.999680 < \text{Drift Ratio} < +1.000320$

## 1A DC Range

## P087 1A Range True Zero Checks

Ohms Current: Deselected. Input Bus: Inputs deselected.  
Measure: 1A DC Range via INT\_SIG\_BUS, 100mV DC Range and A-D.  
No. of Readings: 4 Discarded; 8 Processed.

- 2561 Noise Standard Deviation  $\leq$  10ppm of FS  
2562 Magnitude  $-100\text{ppm of FS} < \text{Mean Magnitude} < +100\text{ppm of FS}$

## Dig. 1A Range True Zero Magnitude Drift

Digital comparison of the present magnitude against that recorded at the most-recent Internal Source Cal.

- 2563 Zero Drift  $-35\text{ppm of FS} < \text{Drift} < +35\text{ppm of FS}$

## P088 1A Range - Gain Checks

Inputs: 10mA Ohms Current via LOW\_SENSE; 1A Selfcal Current Selected.  
Measure: 1A DC Range Shunt value using 100 $\Omega$  Normal Ohms Range.  
No. of Readings: 8 Discarded; 8 Processed.

- 2571 Range Gain Noise Standard Deviation  $\leq$  10ppm of FS  
2572 Range Gain Magnitude  $+0.0096 < \text{Mean Magnitude} < +1.000410$

## Dig. 1A DC Range Gain Magnitude Drift

Digital comparison of the present magnitude against that recorded at the most-recent Internal Source Cal.

- 2573 Range Gain Drift Ratio  $+0.999590 < \text{Drift Ratio} < +1.000410$



Section 2 - Fault Diagnosis

2.6.9 DC Current Tests (Contd.)

Test Setup Models

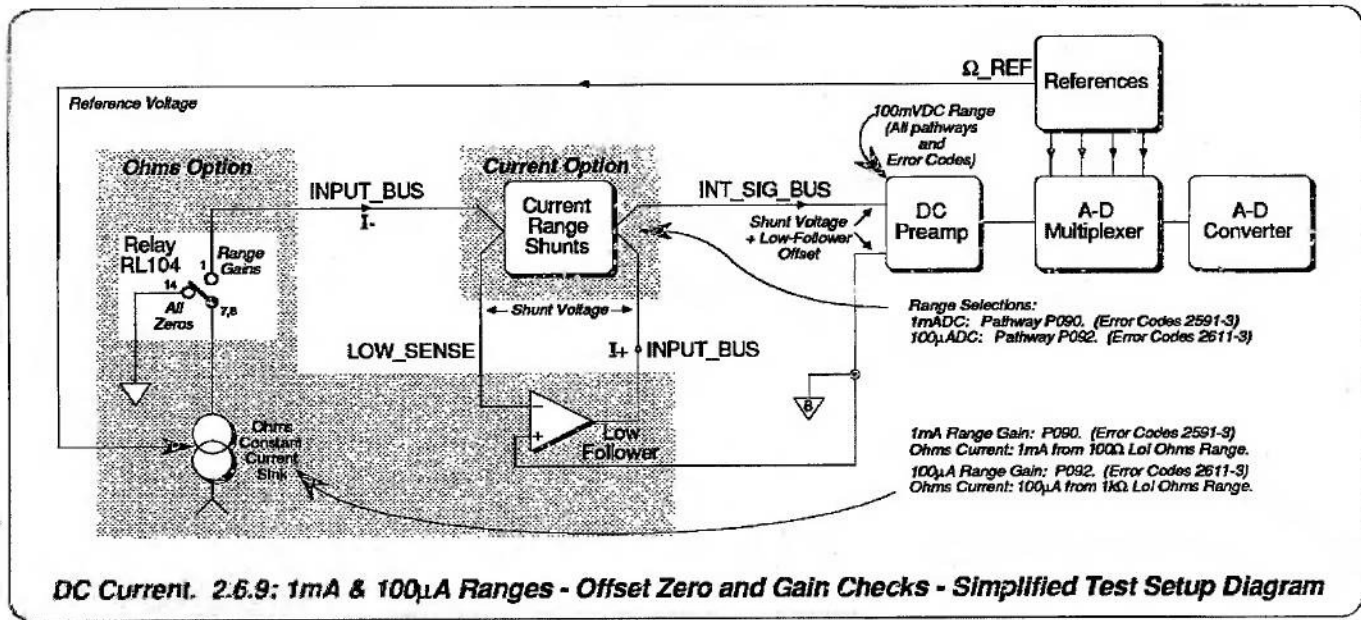
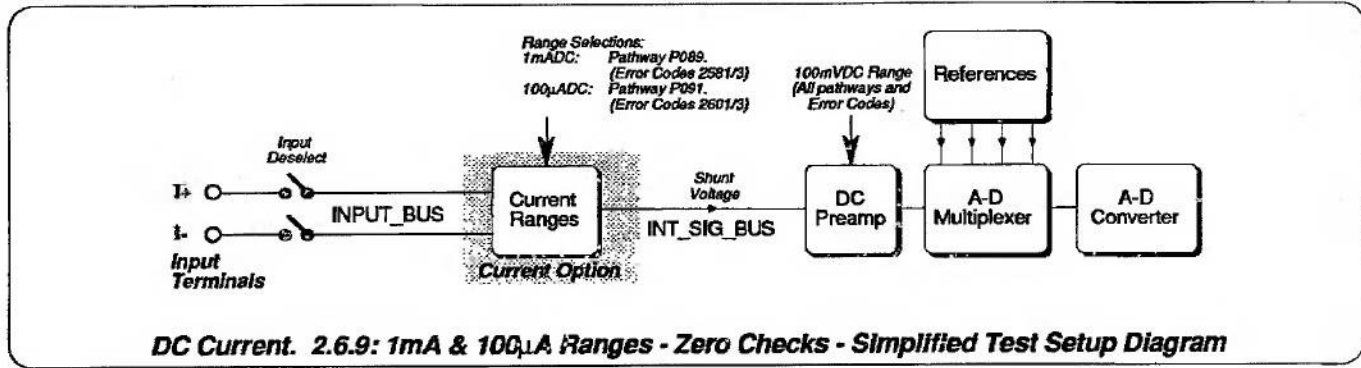

Volume 2 References

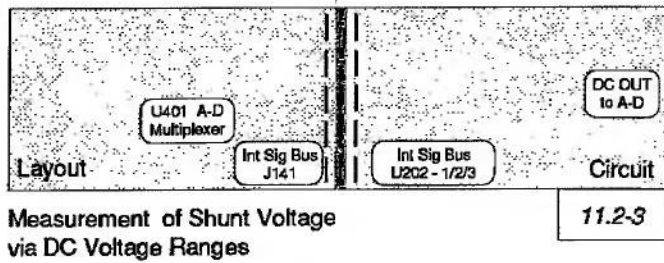
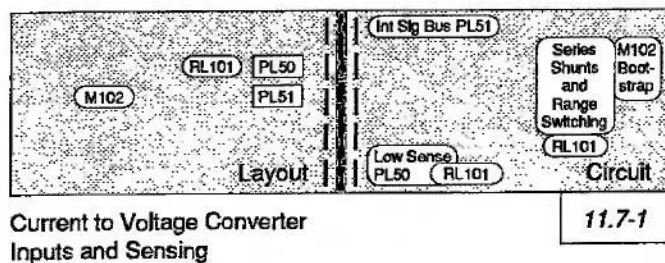
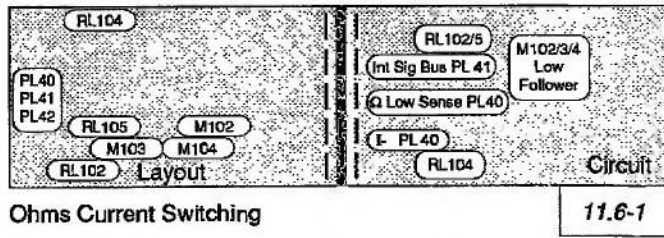
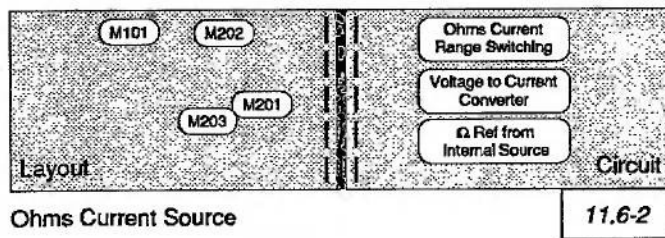



## List of DC Current Measurements (Contd.)

**1mA DC Range****P089 1mA Range True Zero Checks**

Ohms Current: Deselected. Input Bus: Inputs deselected.  
 Measure: 1mA DC Range via INT\_SIG\_BUS, 100mV DC Range and A-D.  
 No. of Readings: 4 Discarded; 8 Processed.

- 2581 Noise Standard Deviation  $\leq$  10ppm of FS  
 2582 Magnitude -100ppm of FS < Mean Magnitude < +100ppm of FS

**Dig. 1mA Range True Zero Magnitude Drift**

Digital comparison of the present magnitude against that recorded at the most-recent Internal Source Cal.

- 2583 Zero Drift P089 4 ; 8 -35ppm of FS < Drift < +35ppm of FS

**P090 1mA Range - Gain Checks**

Inputs: 1mA Ohms Current via LOW\_SENSE; 1mA Selfcal Current Selected.  
 Measure: 1mA DC Range Shunt value using 100 $\Omega$  Lol Ohms Range.  
 No. of Readings: 4 Discarded; 8 Processed.

- 2591 Range Gain Noise Standard Deviation  $\leq$  10ppm of FS  
 2592 Range Gain Magnitude +0.98 < Mean Magnitude < +1.02

**Dig. 1mA DC Range Gain Magnitude Drift**

Digital comparison of the present magnitude against that recorded at the most-recent Internal Source Cal.

- 2593 Magnitude Drift +0.999700 < Drift Ratio < +1.000300

**100 $\mu$ A DC Range****P091 100 $\mu$ A Range True Zero Checks**

Ohms Current: Deselected. Input Bus: Inputs deselected.  
 Measure: 100 $\mu$ A DC Range via INT\_SIG\_BUS, 100mV DC Range and A-D.  
 No. of Readings: 4 Discarded; 8 Processed.

- 2601 Noise Standard Deviation  $\leq$  10ppm of FS  
 2602 Magnitude -100ppm of FS < Mean Magnitude < +100ppm of FS

**Dig. 100 $\mu$ A Range True Zero Magnitude Drift**

Digital comparison of the present magnitude against that recorded at the most-recent Internal Source Cal.

- 2603 Zero Drift -35ppm of FS < Drift < +35ppm of FS

**P092 100 $\mu$ A Range - Gain Checks**

Inputs: 100 $\mu$ A Ohms Current via LOW\_SENSE; 100 $\mu$ A Selfcal Current Selected.  
 Measure: 100 $\mu$ A DC Range Shunt value using 1k $\Omega$  Lol Ohms Range.  
 No. of Readings: 4 Discarded; 8 Processed.

- 2611 Range Gain Noise Standard Deviation  $\leq$  10ppm of FS  
 2612 Range Gain Magnitude +0.98 < Mean Magnitude < +1.02

**Dig. 100 $\mu$ A DC Range Gain Magnitude Drift**

Digital comparison of the present magnitude against that recorded at the most-recent Internal Source Cal.

- 2613 Magnitude Drift Ratio +0.999700 < Drift Ratio < +1.000300



Section 2 - Fault Diagnosis

2.6.10 AC Current Tests

Test Setup Model

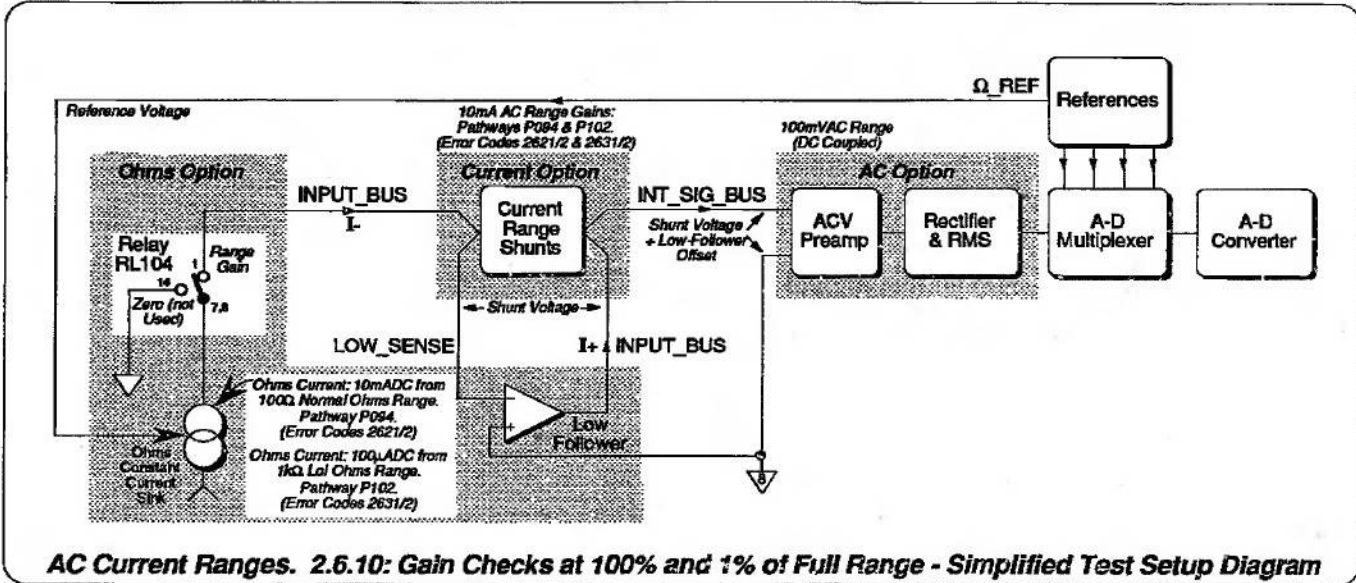

Volume 2 References

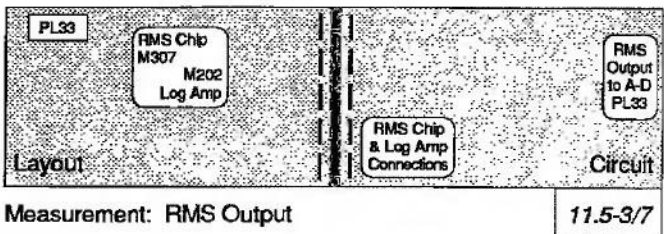
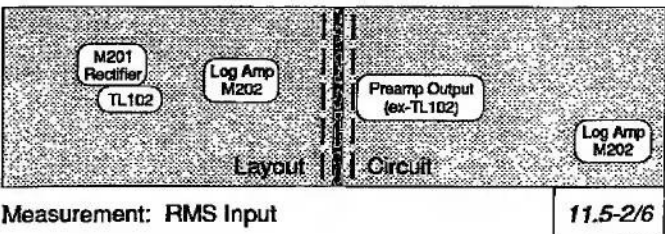
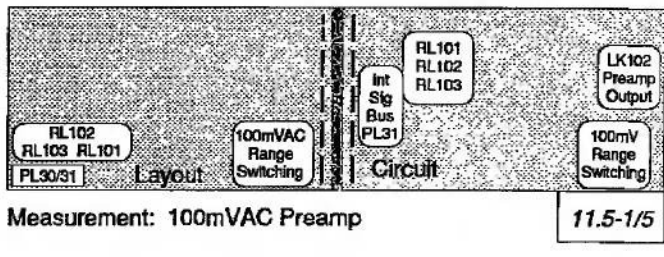
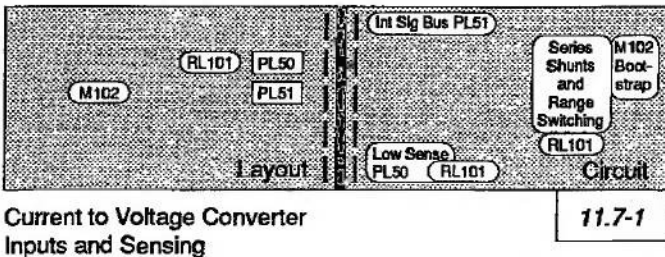
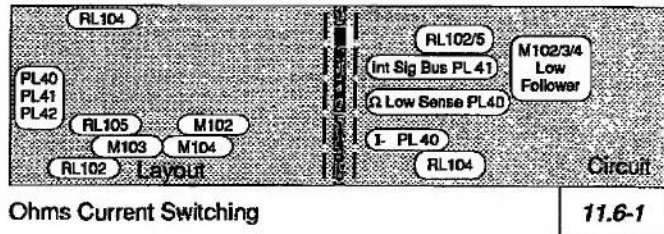
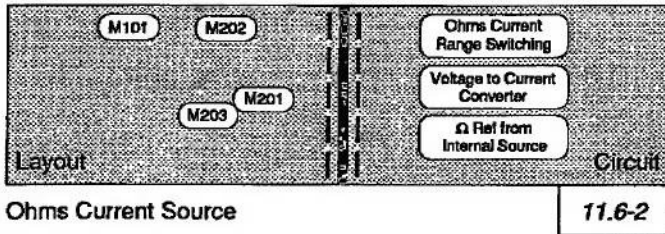

**List of AC Current Measurements****10mA AC Range****P094 10mA AC Range - Gain Checks**

Inputs: 10mA Ohms Current via INPUT\_BUS I-; 10mA Current Range Selected.  
Measure: 10mA Range Gain using 100mV AC Range (DC Coupled) and A-D.  
No. of Readings: 8 Discarded; 8 Processed.

2621 Range Gain Noise           Standard Deviation  $\leq$  10ppm of FS

2622 Range Gain Magnitude    $+0.93 < \text{Mean Magnitude} < +1.07$

**P102 10mA AC Range - AC Zero Checks (AC Zero is 1% FS)**

Inputs: 100 $\mu$ A Ohms Current INPUT\_BUS I-; 10mA Current Range Selected.  
Measure: 10mA Range Zero using 100mV AC Range (DC Coupled) and A-D.  
No. of Readings: 8 Discarded; 8 Processed.

2631 Range Zero Noise           Standard Deviation  $\leq$  10ppm of FS

2632 Range Zero Magnitude    $+0.01 < \text{Zero} < +0.04$



2.6.11 Resistor Ratio Tests

Test Setup Model

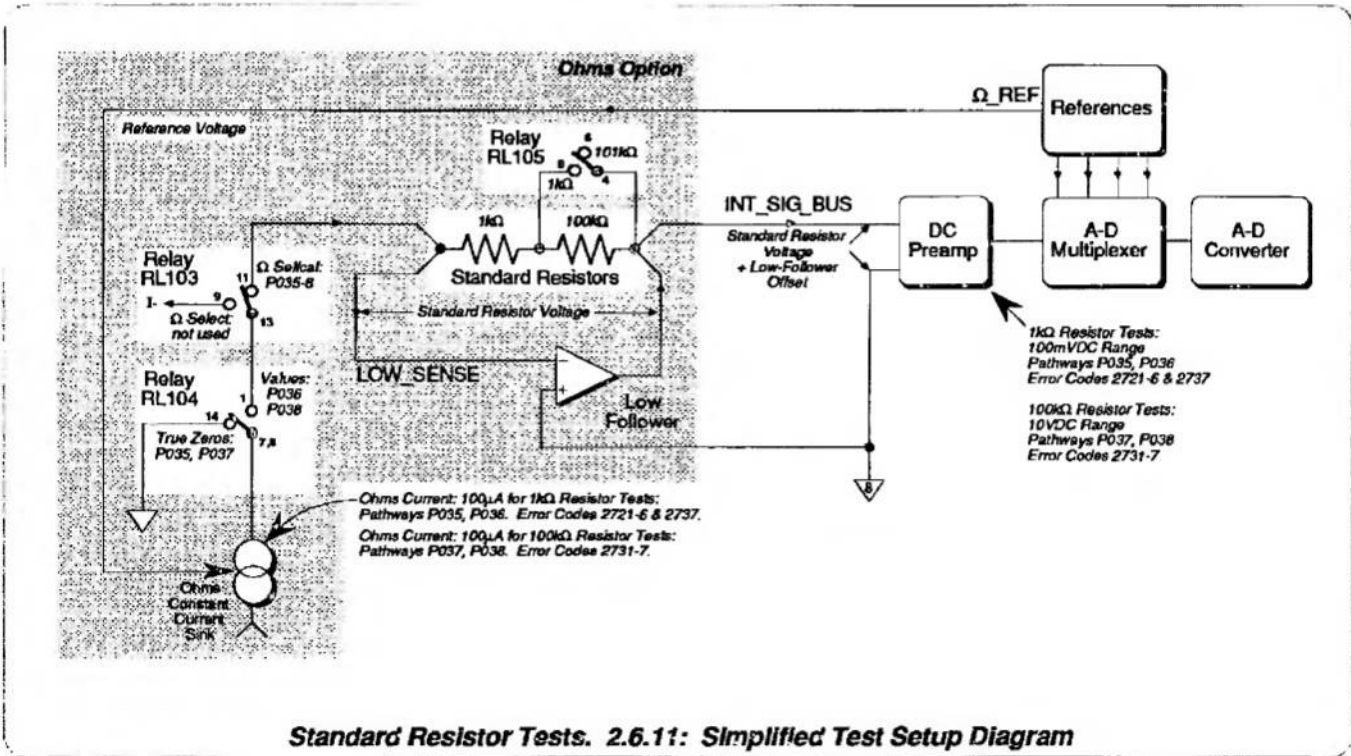

Volume 2 References

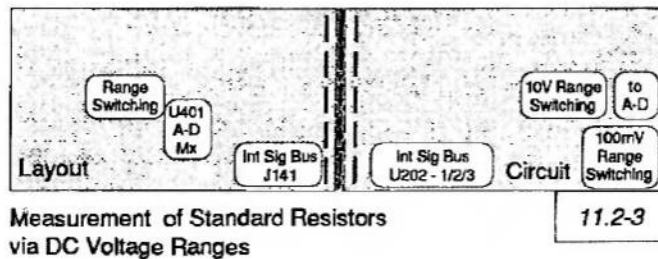
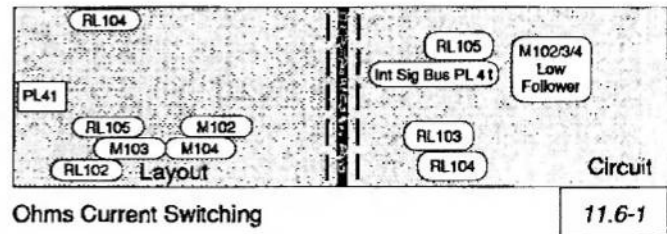
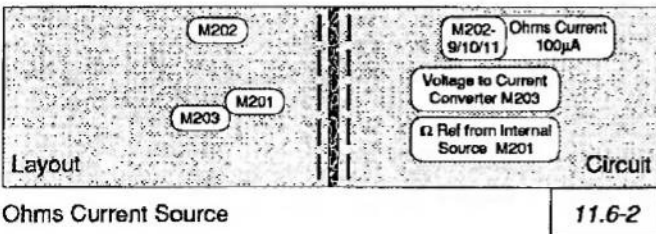

## List of Standard Resistor Measurements

 $\Omega$  Standard ResistorP035 **1k $\Omega$  Standard Resistor True Zero**

Ohms Current: True Zero. DCV Range: 100mV. No. of Readings: 32 Discarded; 8 Processed.

- 2721 Noise Standard Deviation  $\leq$  10ppm of FS  
 2722 Magnitude -200ppm of FS < Mean < +200ppm of FS

Dig. **Zero Drift**

Digital comparison of the present Zero Magnitude against that recorded at the most-recent Internal Source Cal.

- 2723 Magnitude Drift -100ppm of FS < Drift < +100ppm of FS

P036 **1k $\Omega$  Standard Resistor Value**Ohms Current: 100 $\mu$ A. DCV Range: 100mV. No. of Readings: 8 Discarded; 8 Processed.

- 2724 Noise Standard Deviation  $\leq$  10ppm of FS  
 2725 Magnitude +0.98 < Mean < +1.02

Dig. **Value Drift**

Digital comparison of the present Value against that recorded at the most-recent Internal Source Cal.

- 2726 Magnitude Drift 0.999800 < Drift Ratio < 1.000200

100k $\Omega$  Standard ResistorP037 **100k $\Omega$  Standard Resistor True Zero**

Ohms Current: True Zero. DCV Range: 10V. No. of Readings: 8 Discarded; 8 Processed.

- 2731 Noise Standard Deviation  $\leq$  2ppm of FS  
 2732 Magnitude -40ppm of FS < Mean Magnitude < +40ppm of FS

Dig. **Zero Drift**

Digital comparison of the present Zero Magnitude against that recorded at the most-recent Internal Source Cal.

- 2733 Magnitude Drift -5ppm of FS < Drift < +5ppm of FS

P038 **100k $\Omega$  Standard Resistor Value**Ohms Current: 100 $\mu$ A. DCV Range: 10V. No. of Readings: 8 Discarded; 8 Processed.

- 2734 Noise Standard Deviation  $\leq$  2ppm of FS  
 2735 Magnitude +0.98 < Magnitude < +1.02

Dig. **Value Drift**

Digital comparison of the present Value against that recorded at the most-recent Internal Source Cal.

- 2736 Magnitude Drift 0.999750 < Drift Ratio < 1.000250

## Standard Resistor Ratio

Dig. **Value Drift**Digital comparison of the ratio between the present 100k $\Omega$  and 1k $\Omega$  Values against the corresponding ratio recorded at the most-recent calibration.

- 7 Value-Ratio Drift -100ppm < Drift < +100ppm



Section 2 - Fault Diagnosis

2.6.12 Ohms Tests

Test Setup Model

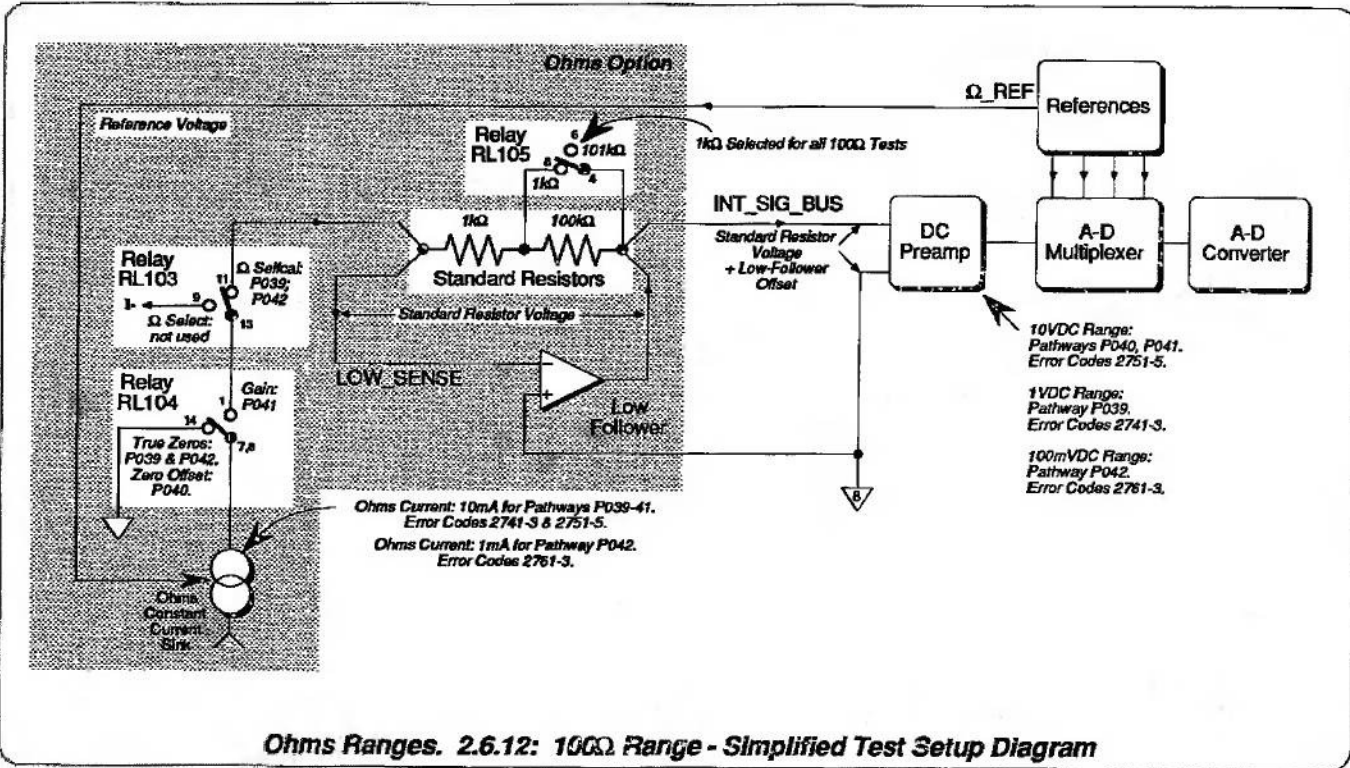

Volume 2 References

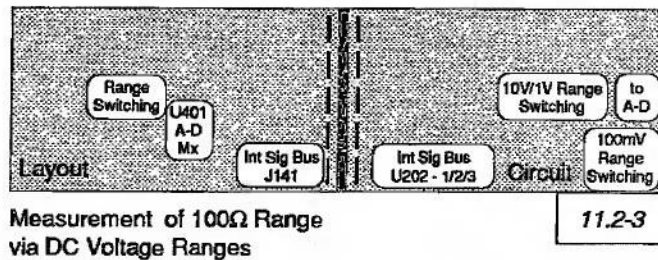
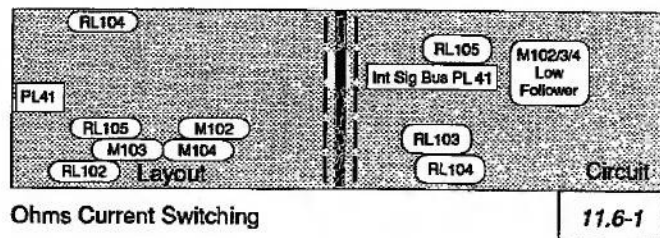
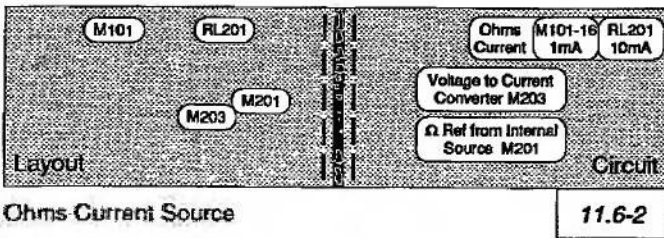

## List of Ohms Measurements

## 100Ω Range

P039 **100Ω Range True Zero** (Measured using the 1V DC Range)  
 Ohms Current: True Zero (10mA selected). Standard Resistor: 1kΩ. DCV Range: 1V.  
 No. of Readings: 4 Discarded; 8 Processed.

2741 Noise Standard Deviation  $\leq$  5ppm of FS

2742 Magnitude -40ppm of FS < Mean Magnitude < +40ppm of FS

## Dig. Zero Drift

Digital comparison of the present Zero Magnitude against that recorded at the most-recent Internal Source Cal.

2743 Magnitude Drift -15ppm of FS < Drift < +15ppm of FS

P040 **100Ω Range Zero** (Measured using the 10V DC Range)  
 Ohms Current: True Zero (10mA selected). Standard Resistor: 1kΩ. DCV Range: 10V.  
 No. of Readings: 4 Discarded; 8 Processed.

2751 Noise Standard Deviation  $\leq$  3ppm of FS

2752 Magnitude -50ppm of FS < Mean Magnitude < +50ppm of FS

P041 **100Ω Range Gain** (Measured using the 10V DC Range)  
 Ohms Current: 10mA. Standard Resistor: 1kΩ. DCV Range: 10V.  
 No. of Readings: 4 Discarded; 8 Processed.

2753 Noise Standard Deviation  $\leq$  3ppm of FS

2754 Magnitude +0.96 < Mean Magnitude < 1.04

## Gain Drift

Digital comparison of the present Gain Magnitude against that recorded at the most-recent Internal Source Cal.

2755 Magnitude Drift 0.999750 < Drift Ratio < 1.000250

P042 **100Ω Range True Zero** (Measured using the 100mV DC Range)  
 Ohms Current: True Zero (1mA selected). Standard Resistor: 1kΩ. DCV Range: 100mV.  
 No. of Readings: 4 Discarded; 8 Processed.

2761 Noise Standard Deviation  $\leq$  15ppm of FS

2762 Magnitude -200ppm of FS < Mean Magnitude < +200ppm of FS

## Dig. Zero Drift

Digital comparison of the present Zero Magnitude against that recorded at the most-recent Internal Source Cal.

2763 Magnitude Drift -100ppm of FS < Drift < +100ppm of FS



Section 2 - Fault Diagnosis

2.6.12 Ohms Tests (Contd.)

Test Setup Model

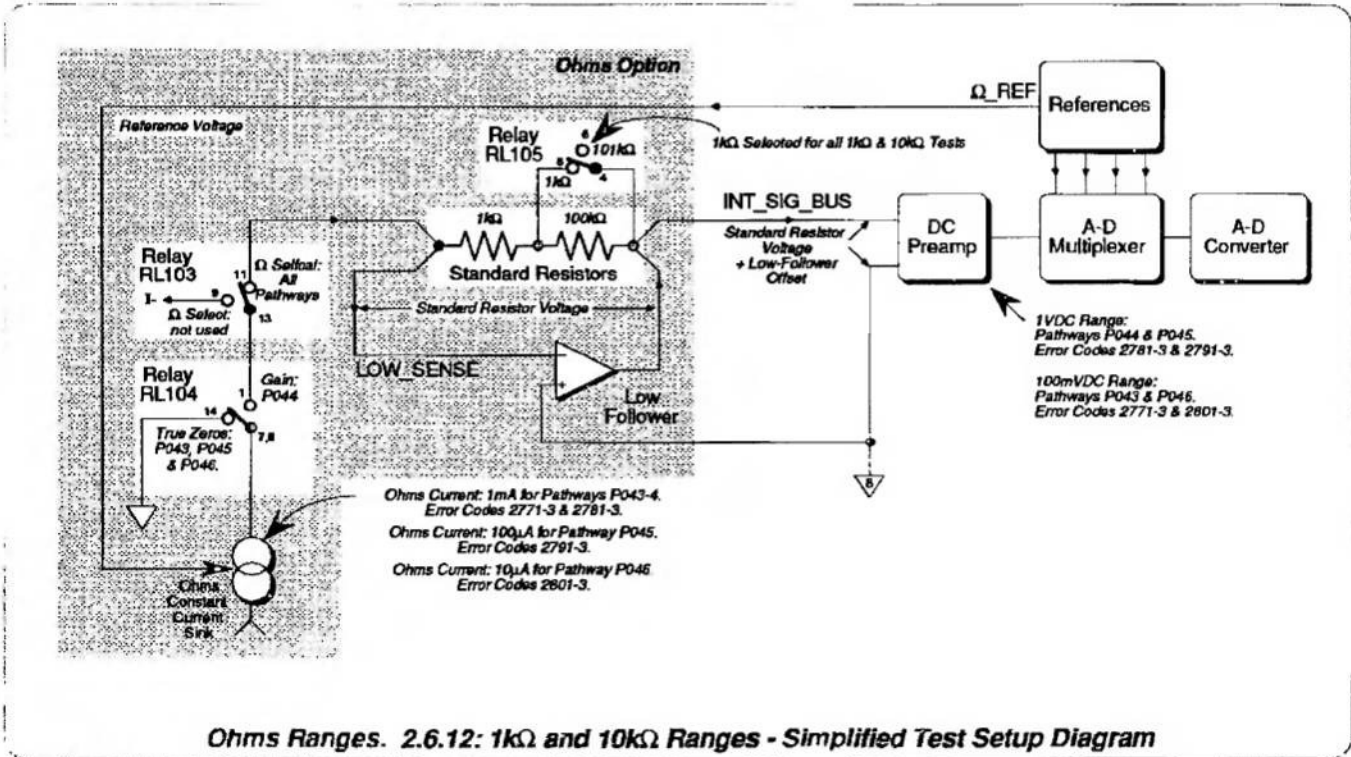

Volume 2 References

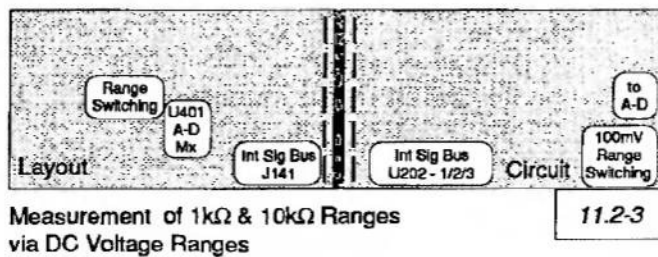
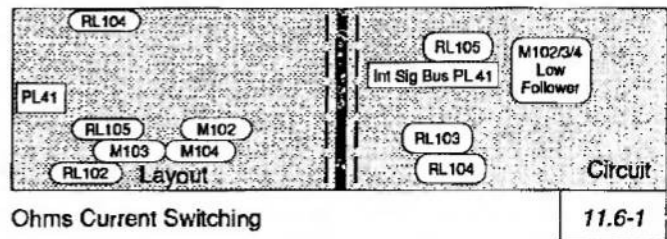
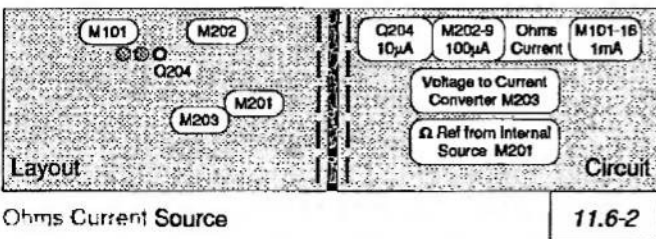

## List of Ohms Measurements (Contd.)

 $\Omega$  Range

P043 **1k $\Omega$  Range True Zero** (Measured using the 1V DC Range)  
Ohms Current: True Zero (1mA selected). Standard Resistor: 1k $\Omega$ . DCV Range: 1V.  
No. of Readings: 4 Discarded; 8 Processed.

2771 Noise Standard Deviation  $\leq$  5ppm of FS  
2772 Magnitude -40ppm of FS < Mean Magnitude < +40ppm of FS

Dig. **Zero Drift**

Digital comparison of the present Zero Magnitude against that recorded at the most-recent Internal Source Cal.

2773 Magnitude Drift -15ppm of FS < Drift < +15ppm of FS

P044 **1k $\Omega$  Range Gain** (Measured using the 1V DC Range)  
Ohms Current: 1mA. Standard Resistor: 1k $\Omega$ . DCV Range: 1V.  
No. of Readings: 4 Discarded; 8 Processed.

2781 Noise Standard Deviation  $\leq$  5ppm of FS  
2782 Magnitude +0.96 < Mean Magnitude < +1.04

Dig. **Gain Drift**

Digital comparison of the present Gain Magnitude against that recorded at the most-recent Internal Source Cal.

2783 Magnitude Drift 0.999750 < Drift Ratio < 1.000250

10k $\Omega$  Range

P045 **10k $\Omega$  Range True Zero** (Measured using the 1V DC Range)  
Ohms Current: True Zero (100 $\mu$ A selected). Standard Resistor: 1k $\Omega$ . DCV Range: 1V.  
No. of Readings: 4 Discarded; 8 Processed.

2791 Noise Standard Deviation  $\leq$  5ppm of FS  
2792 Magnitude -40ppm of FS < Mean Magnitude < +40ppm of FS

Dig. **Zero Drift**

Digital comparison of the present Zero Magnitude against that recorded at the most-recent Internal Source Cal.

2793 Magnitude Drift -15ppm of FS < Drift < +15ppm of FS

P046 **10k $\Omega$  Range True Zero** (Measured using the 100mV DC Range)  
Ohms Current: True Zero (10 $\mu$ A selected). Standard Resistor: 1k $\Omega$ . DCV Range: 100mV.  
No. of Readings: 4 Discarded; 8 Processed.

2801 Noise Standard Deviation  $\leq$  15ppm of FS  
2802 Magnitude -200ppm of FS < Mean Magnitude < +200ppm of FS

Dig. **Zero Drift**

Digital comparison of the present Zero Magnitude against that recorded at the most-recent Internal Source Cal.

2803 Magnitude Drift -100ppm of FS < Drift < +100ppm of FS



Section 2 - Fault Diagnosis

2.6.12 Ohms Tests (Contd.)

Test Setup Model

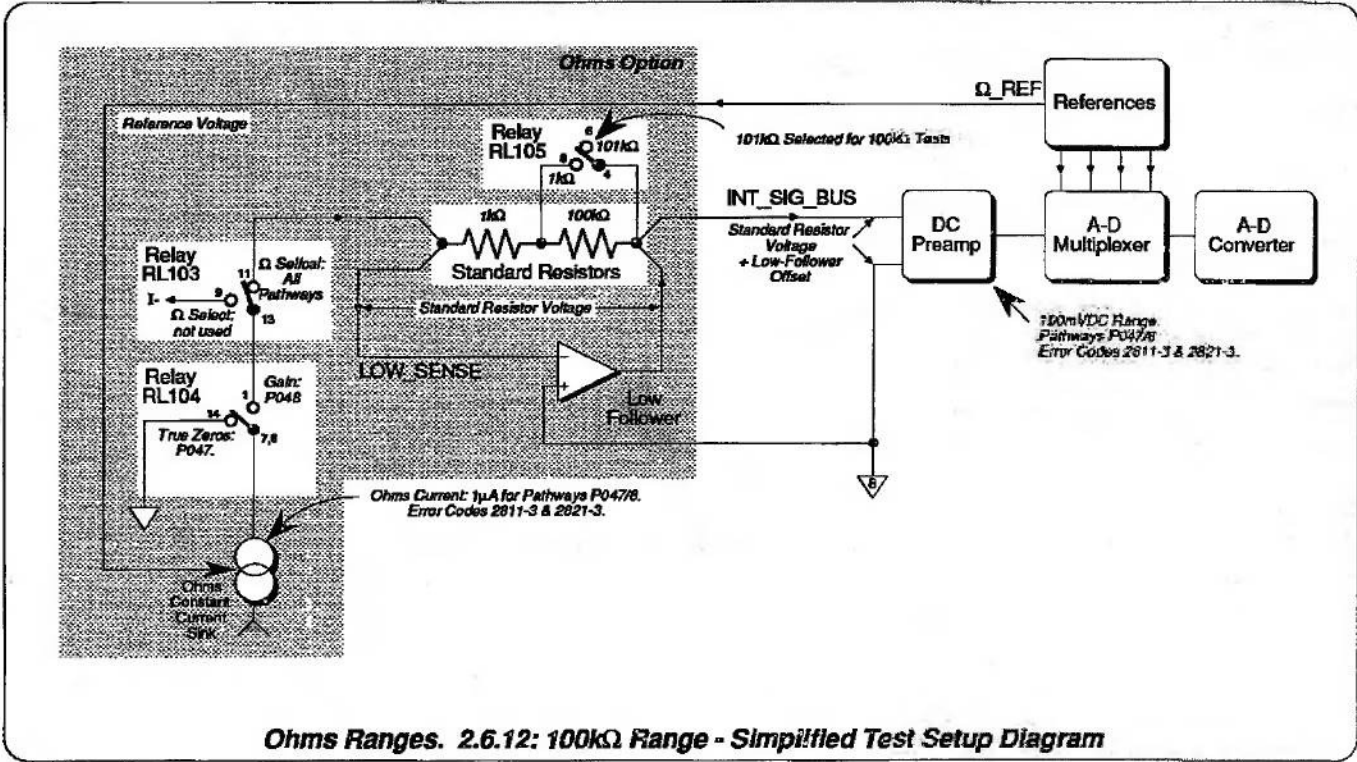

Volume 2 References

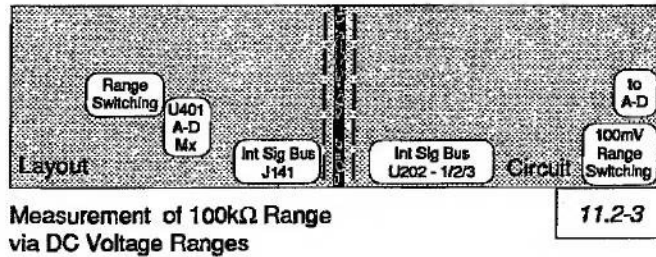
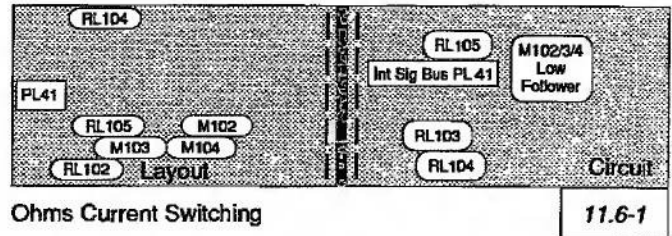
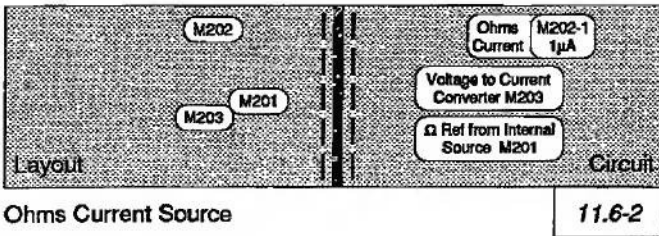

## List of Ohms Measurements (Contd.)

## 0kΩ Range

- P047 **100kΩ Range True Zero** (Measured using the 100mV DC Range)  
 Ohms Current: True Zero (1μA selected). Standard Resistor: 100kΩ. DCV Range: 100mV.  
 No. of Readings: 4 Discarded; 8 Processed.
- 2811 Noise Standard Deviation  $\leq$  15ppm of FS  
 2812 Magnitude  $-2500\text{ppm} < \text{Mean Magnitude} < +2500\text{ppm}$
- Dig. **Zero Drift**  
 Digital comparison of the present Zero Magnitude against that recorded at the most-recent Internal Source Cal.
- 2813 Magnitude Drift  $-100\text{ppm of FS} < \text{Drift} < +100\text{ppm of FS}$
- P048 **100kΩ Range Gain** (Measured using the 100mV DC Range)  
 Ohms Current: 1μA. Standard Resistor: 100kΩ. DCV Range: 100mV.  
 No. of Readings: 4 Discarded; 8 Processed.
- 2821 Noise Standard Deviation  $\leq$  15ppm of FS  
 2822 Magnitude  $+0.96 < \text{Mean Magnitude} < +1.04$
- Dig. **Gain Drift**  
 Digital comparison of the present Gain Magnitude against that recorded at the most-recent Internal Source Cal.
- 2823 Magnitude Drift  $0.999650 < \text{Drift Ratio} < 1.000350$



2.6.12 Ohms Tests (Contd.)

Test Setup Model

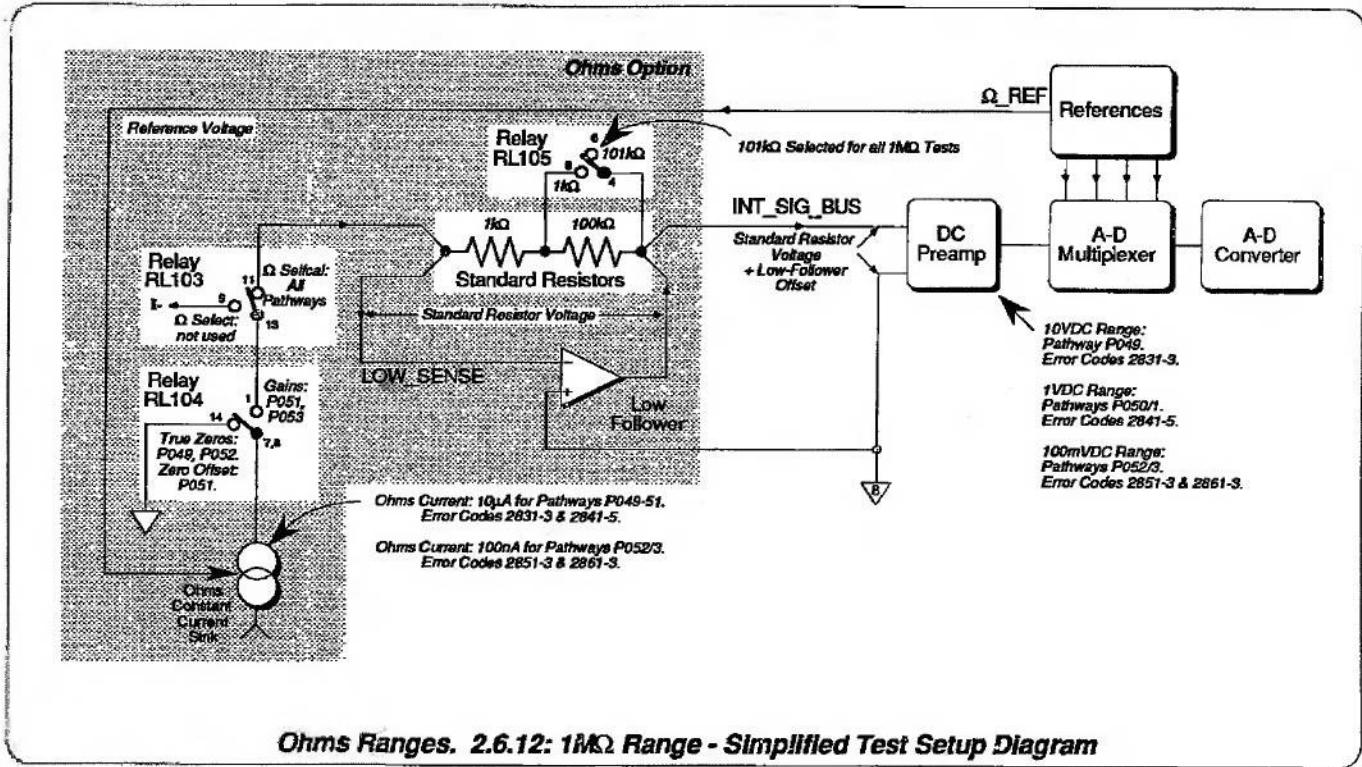

Volume 2 References

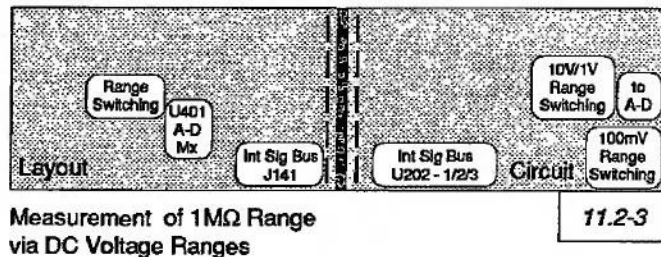
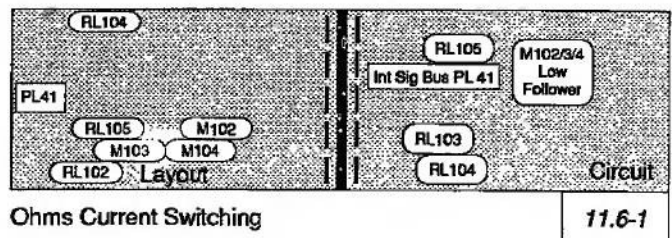
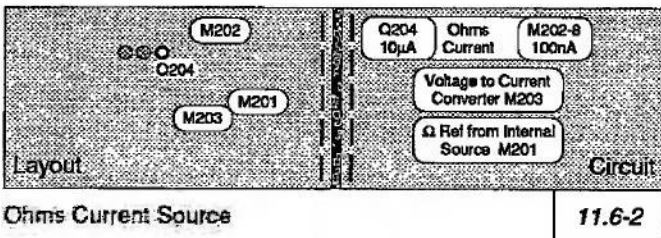



## List of Ohms Measurements (Contd.)

**1MΩ Range**

- P049 1MΩ Range True Zero (Measured using the 10V DC Range)**  
Ohms Current: True Zero (10μA selected). Standard Resistor: 100kΩ. DCV Range: 10V.  
No. of Readings: 4 Discarded; 8 Processed.
- 2831 Noise Standard Deviation ≤ 3ppm of FS
- 2832 Magnitude -40ppm of FS < Mean Magnitude < +40ppm of FS
- Dig. Zero Drift**  
Digital comparison of the present Zero Magnitude against that recorded at the most-recent Internal Source Cal.
- 2833 Magnitude Drift -5ppm of FS < Drift < +5ppm of FS
- P050 1MΩ Range Zero (Measured using the 1V DC Range)**  
Ohms Current: True Zero (10μA selected). Standard Resistor: 100kΩ. DCV Range: 1V.  
No. of Readings: 4 Discarded; 8 Processed.
- 2841 Noise Standard Deviation ≤ 5ppm of FS
- 2842 Magnitude -50ppm of FS < Mean Magnitude < +50ppm of FS
- P051 1MΩ Range Gain (Measured using the 1V DC Range)**  
Ohms Current: 10μA. Standard Resistor: 100kΩ. DCV Range: 1V.  
No. of Readings: 4 Discarded; 8 Processed.
- 2843 Noise Standard Deviation ≤ 5ppm of FS
- 2844 Magnitude +0.96 < Mean Magnitude < +1.04
- Dig. Gain Drift**  
Digital comparison of the present Gain Magnitude against that recorded at the most-recent Internal Source Cal.
- 2845 Magnitude Drift +0.999750 < Drift Ratio < +1.000250
- P052 1MΩ Range True Zero (Measured using the 100mV DC Range)**  
Ohms Current: True Zero (100nA selected). Standard Resistor: 100kΩ. DCV Range: 100mV.  
No. of Readings: 4 Discarded; 8 Processed.
- 2851 Noise Standard Deviation ≤ 15ppm of FS
- 2852 Magnitude -2500ppm < Mean Magnitude < +2500ppm
- Dig. Zero Drift**  
Digital comparison of the present Zero Magnitude against that recorded at the most-recent Internal Source Cal.
- 2853 Magnitude Drift -100ppm of FS < Drift < +100ppm of FS
- P053 1MΩ Range Gain (Measured using the 100mV DC Range)**  
Ohms Current: 100nA selected. Standard Resistor: 100kΩ. DCV Range: 100mV.  
No. of Readings: 4 Discarded; 8 Processed.
- 2861 Noise Standard Deviation ≤ 15ppm of FS
- 2862 Magnitude +0.096 < Mean Magnitude < +0.104
- Dig. Gain Drift**  
Digital comparison of the present Gain Magnitude against that recorded at the most-recent Internal Source Cal.
- 2863 Magnitude Drift 0.999000 < Drift Ratio < 1.001000

2.6.13 High Ohms Tests

Test Setup Model

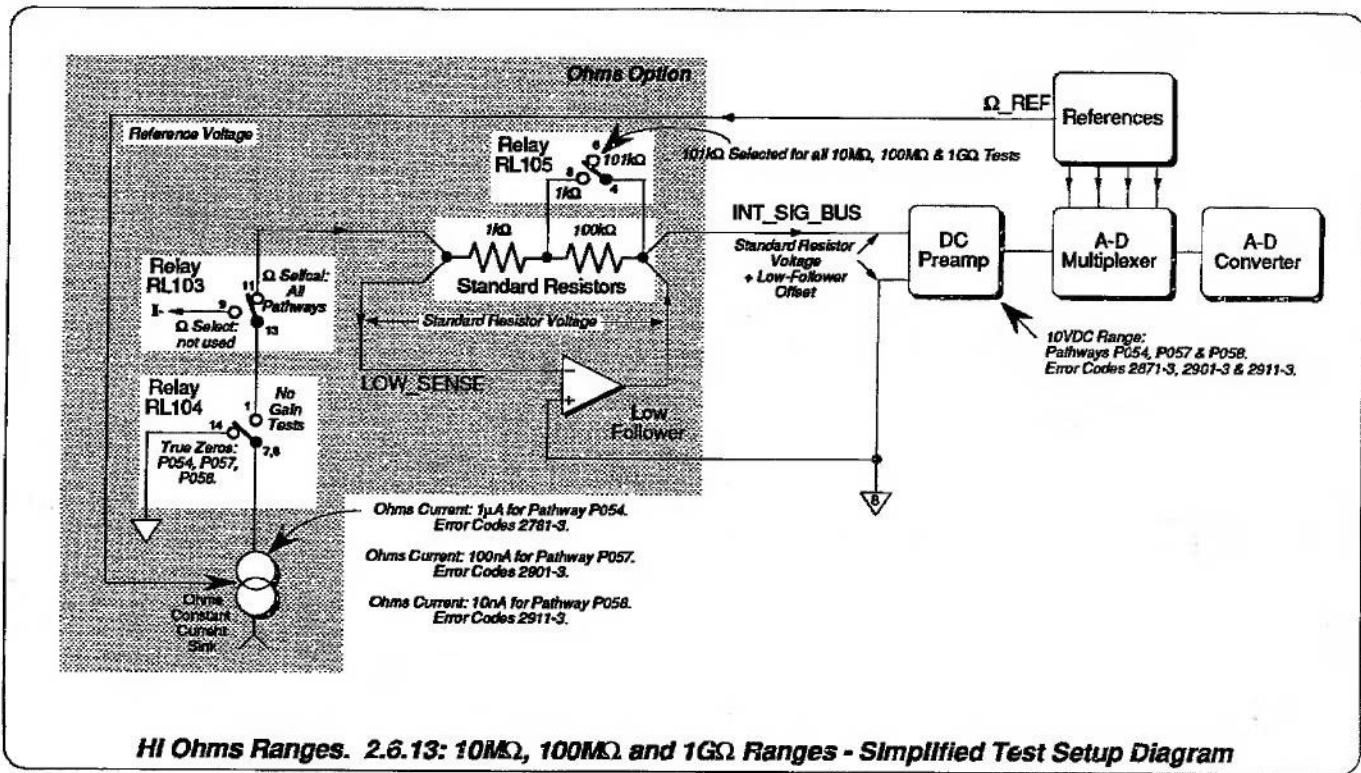

Volume 2 References

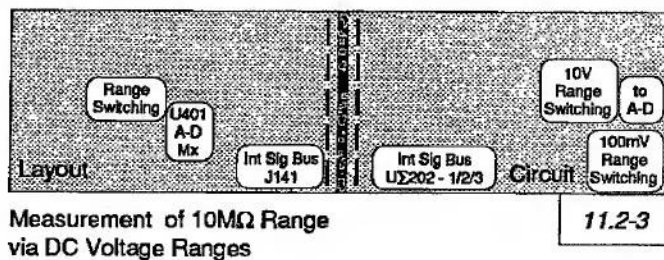
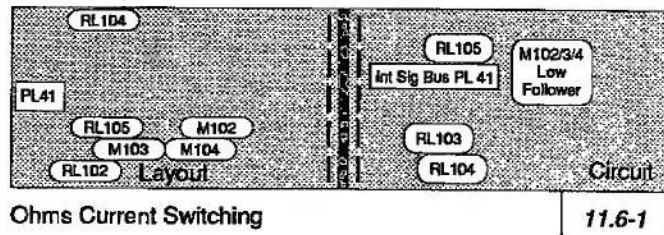
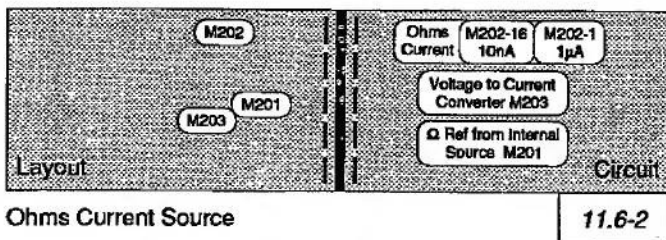



## List of Hi Ohms Measurements

M $\Omega$  Range

- P054 **10M $\Omega$  Range True Zero** (Measured using 1 $\mu$ A Ohms Current)  
 Ohms Current: True Zero (1 $\mu$ A selected). Standard Resistor: 100k $\Omega$ . DCV Range: 10V.  
 No. of Readings: 4 Discarded; 8 Processed.
- 2871 Noise Standard Deviation  $\leq$  3ppm of FS
- 2872 Magnitude -40ppm of FS < Mean Magnitude < +40ppm of FS
- Dig. **Zero Drift**  
 Digital comparison of the present Zero Magnitude against that recorded at the most-recent Internal Source Cal.
- 2873 Magnitude Drift 100ppm of FS < Drift < +100ppm of FS

100M $\Omega$  Range

- P057 **100M $\Omega$  Range True Zero**  
 Ohms Current: True Zero (100nA selected). Standard Resistor: 100k $\Omega$ . DCV Range: 10V.  
 No. of Readings: 4 Discarded; 8 Processed.
- 2901 Noise Standard Deviation  $\leq$  2ppm of FS
- 2902 Magnitude -20ppm of FS < Magnitude < +20ppm of FS
- Dig. **Zero Drift**  
 Digital comparison of the present Zero Magnitude against that recorded at the most-recent Internal Source Cal.
- 2903 Magnitude Drift -100ppm of FS < Drift < +100ppm of FS

1G $\Omega$  Range

- P058 **1G $\Omega$  Range True Zero**  
 Ohms Current: True Zero (10nA selected). Standard Resistor: 100k $\Omega$ . DCV Range: 10V.  
 No. of Readings: 4 Discarded; 8 Processed.
- 2911 Noise Standard Deviation  $\leq$  2ppm of FS
- 2912 Magnitude -20ppm of FS < Magnitude < +20ppm of FS
- Dig. **Zero Drift**  
 Digital comparison of the present Zero Magnitude against that recorded at the most-recent Internal Source Cal.
- 2913 Magnitude Drift -100ppm of FS < Drift < +100ppm of FS

## 2.7 Fast Selftest

### Reference Ratio Test Setup Model

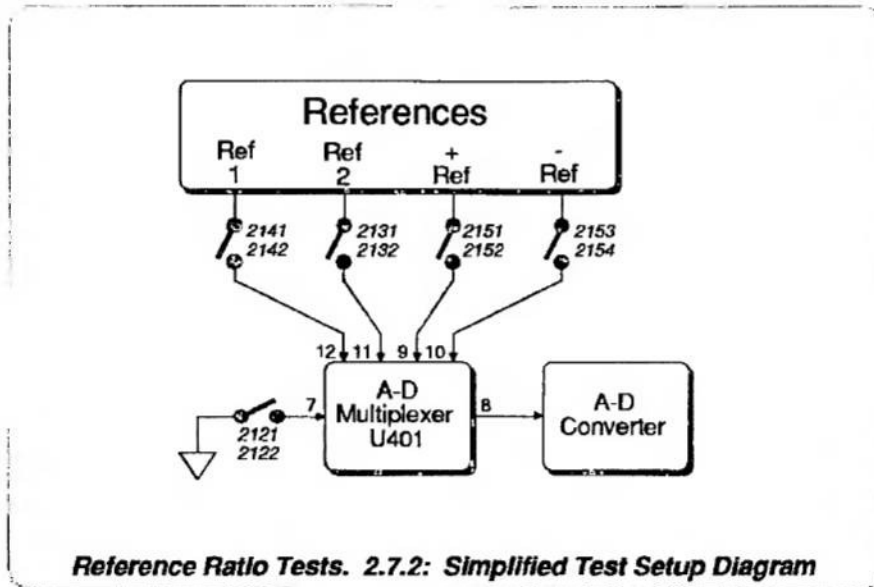

### Volume 2 References

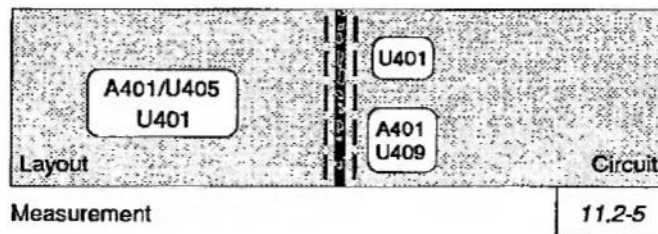



## List of Memory Tests and Reference Ratio Measurements

**7.1 Memory Tests****2.7.1.1 Non-volatile RAM Checksum Errors**

2100	Primary.
2101	Secondary.
2102	Input Zero.
2103	Frequency.

**2.7.1.2 Fuse Test**

P084	
2111	Indicates that the fuse is open-circuit / blown

**2.7.2 Reference Ratio Tests****P129 Ref Zero Checks**

Input: Hard Zero to A-D Multiplexer. Measure: via A-D. No. of Readings: 8 Discarded; 16 Processed.

2121	Noise	Standard Deviation $\leq$ 60ppm
2122	Magnitude	$-400\text{ppm} \leq   \text{Mean Ref zero}   \leq +400\text{ppm}$

**P131 Ref 2 Checks**

Input: Ref 2 to A-D Multiplexer. Measure: via A-D. No. of Readings: 8 Discarded; 16 Processed.

2131	Noise	Standard Deviation $\leq$ 60ppm
2132	Magnitude	$-1.46 \leq \text{Mean Ref 2} \leq -1.34$

**P130 Ref 1 Checks**

Input: Ref 1 to A-D Multiplexer. Measure: via A-D. No. of Readings: 8 Discarded; 16 Processed.

2141	Noise	Standard Deviation $\leq$ 60ppm
2142	Magnitude	$-1.47492 \leq \text{Mean Ref 1} \leq -1.41708$

**P132 Positive Ref Checks**

Input: +Ref to A-D Multiplexer. Measure: via A-D. No. of Readings: 8 Discarded; 16 Processed.

2151	Noise	Standard Deviation $\leq$ 60ppm
2152	Magnitude	$+1.9992 < \text{Mean +Ref} < +2.0008$

**P133 Negative Ref Checks**

Input: -Ref to A-D Multiplexer. Measure: via A-D. No. of Readings: 8 Discarded; 16 Processed.

2153	Noise	Standard Deviation $\leq$ 60ppm
2154	Magnitude	$-2.0008 < \text{Mean -Ref} < -1.9992$

2.7.3 DC Voltage Tests

Test Setup Model

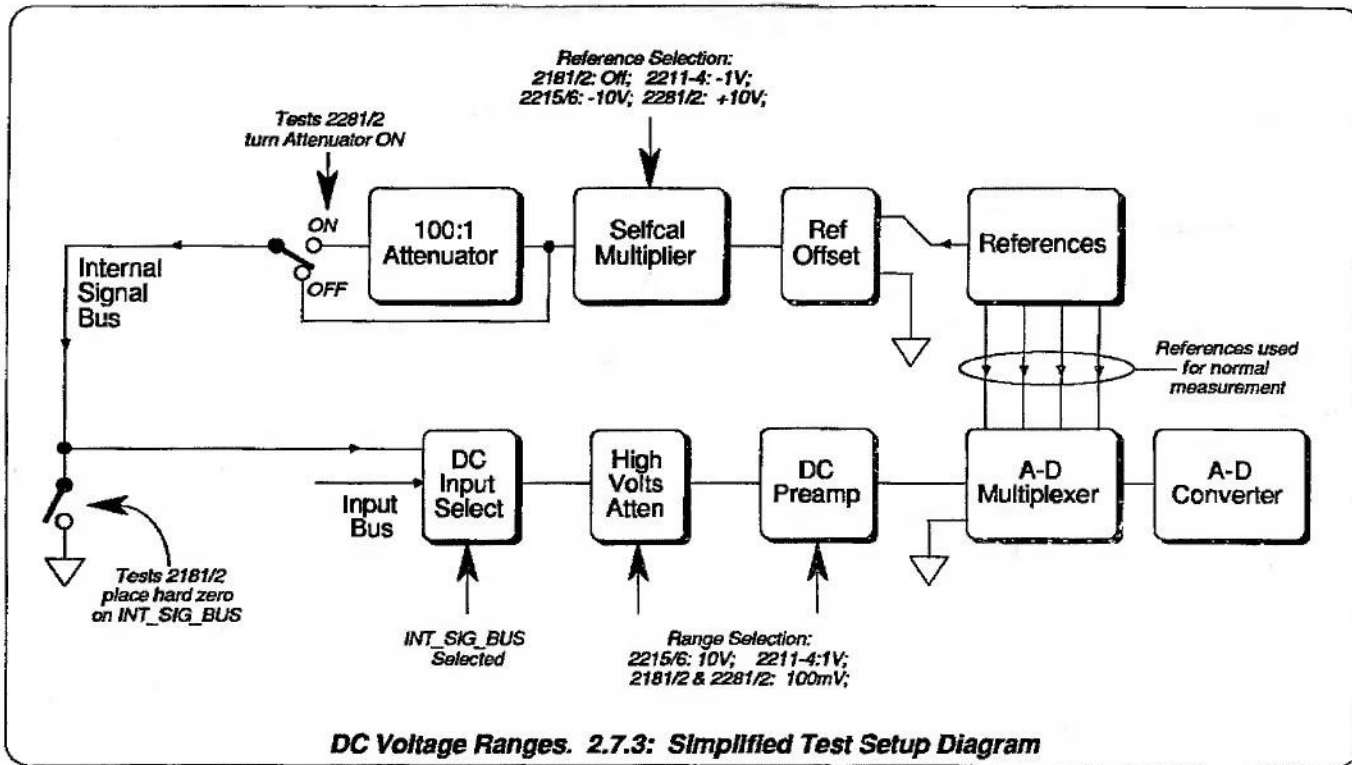

Volume 2 References

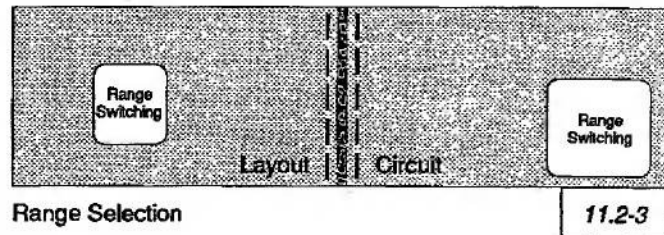
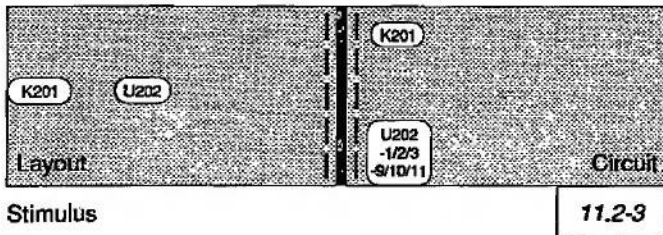



## List of DC Voltage Measurements

## 7.3.1 True Zero Checks

## P144 100mV Range True Zero Checks

Input: Zero to 100mVDC Range. Measure: via A-D. No of Readings: 8 Discarded; 16 Processed.

- 2181 Noise Standard Deviation  $\leq$  50ppm  
 2182 Magnitude  $-250\text{ppm} < \text{Mean } 100\text{mV Zero} < +250\text{ppm}$

2.7.3.2 Negative Gain Measurements  
[Offset (Zero) and References]

## P142 1V Range -Offset Zero Checks

Input: -Offset to 1VDC Range. Measure: via A-D. No of Readings: 32 Discarded; 8 Processed.

- 2211 Noise Standard Deviation  $\leq$  10000ppm  
 2212 Magnitude  $-2500\text{ppm} < \text{Mean } -1\text{V Offset} < +2500\text{ppm}$

## P143 1V Range -Reference Checks

Input: -1V Reference to 1VDC Range. Measure: via A-D. No of Readings: 16 Discarded; 8 Processed.

- 2213 Noise Standard Deviation  $\leq$  10000ppm  
 2214 Magnitude  $-1.04 < \text{Mean } -1\text{V Ref} < -0.96$

## P138 10V Range -Reference Checks

Input: -10V Reference to 10VDC Range. Measure: via A-D. No of Readings: 16 Discarded; 8 Processed.

- 2215 Noise Standard Deviation  $\leq$  10000ppm  
 2216 Magnitude  $-1.02 < -10\text{V Ref} < -0.94$

## 2.7.3.3 Positive Gain Measurements

## P153 100mV Range - Attenuated +10V Reference Checks

Input: +10V DC via 100:1 attenuator to 100mV DC Range. Measure: via A-D.  
No of Readings: 8 Discarded; 16 Processed.

- 2281 +100mV Signal Noise Standard Deviation of +100mV signal  $\leq$  100ppm  
 2282 Magnitude  $+0.94\text{mV} < +100\text{mV Signal Magnitude} < +1.02$

## 2.7.4 AC Voltage Tests

### Test Setup Model

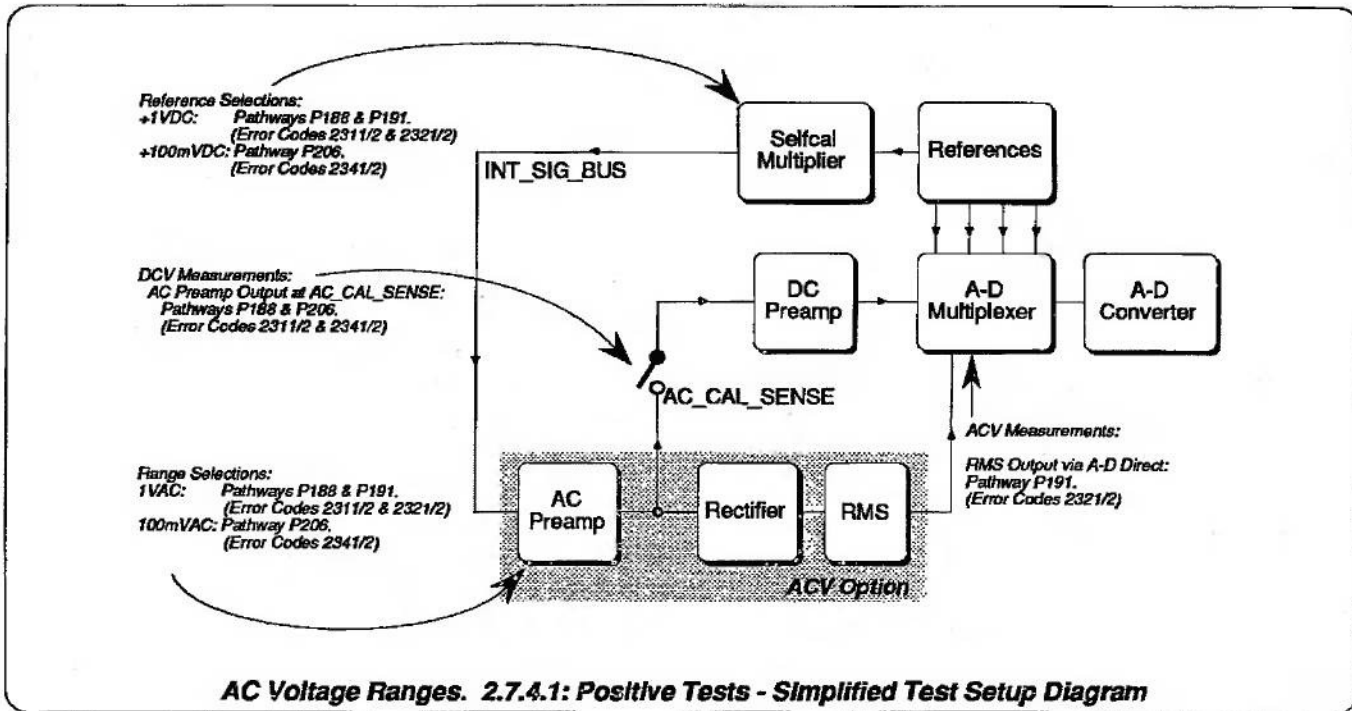

### Volume 2 References

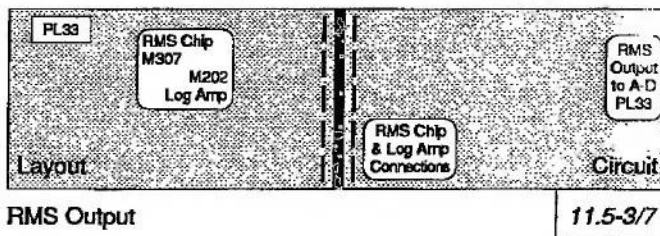
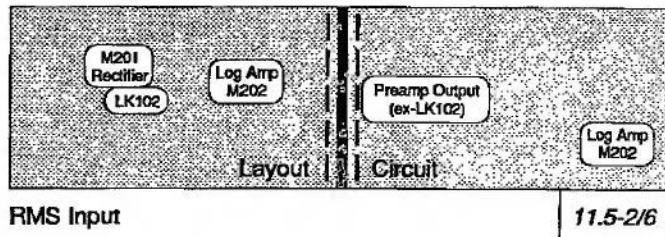
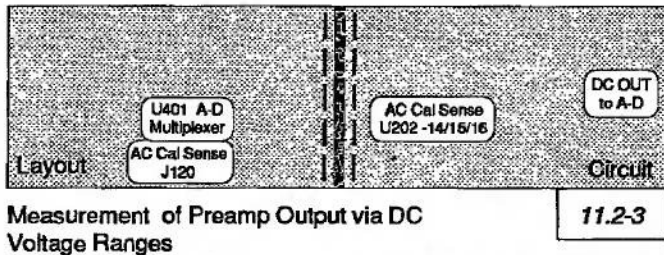
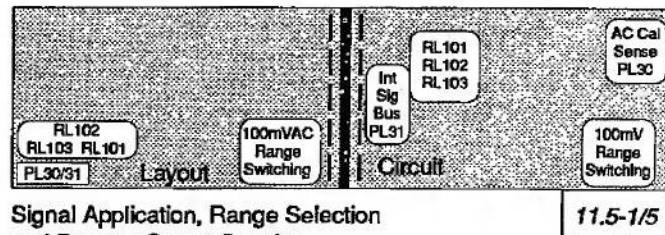
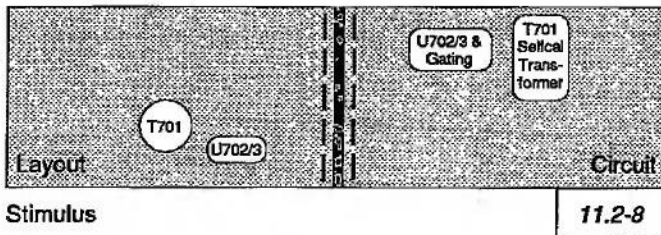



**List of AC Voltage Measurements****7.4.1 Positive Tests****1V AC Range**

- P188 +1V DC Input - Checks at AC Preamp Output**  
Input: +1VDC to AC Preamp set to 1VAC Range.  
Measure: Preamp Output using 1V DC Range at AC\_CAL\_SENSE.  
No. of Readings: 24 Discarded; 8 Processed.
- 2311** Preamp Output Noise      Standard Deviation  $\leq$  10000ppm
- 2312** Preamp Output Magnitude       $-1.04 < \text{Mean Signal} < -0.96$
- P191 +1V DC Input - Checks at RMS Converter Output**  
Input: +1VDC to AC Preamp set to 1VAC Range. Measure: RMS Output via A-D.  
No. of Readings: 24 Discarded; 8 Processed.
- 2321** +RMS Output Noise      Standard Deviation  $\leq$  10000ppm
- 2322** +RMS Output Magnitude       $+0.96 < \text{Mean Signal} < +1.04$

**100mV AC Range**

- P206 +100mV DC Input - Checks at AC Preamp Output**  
Input: +100mVDC to AC Preamp set to 100mVAC Range.  
Measure: Preamp Output using 1V DC Range at AC\_CAL\_SENSE.  
No. of Readings: 24 Discarded; 8 Processed.
- 2341** Preamp Output Noise      Standard Deviation  $\leq$  10000ppm
- 2342** Preamp Output Magnitude       $-2.00 < \text{Mean Signal} < -1.70$



2.7.4 AC Voltage Tests (Contd.)

Test Setup Model

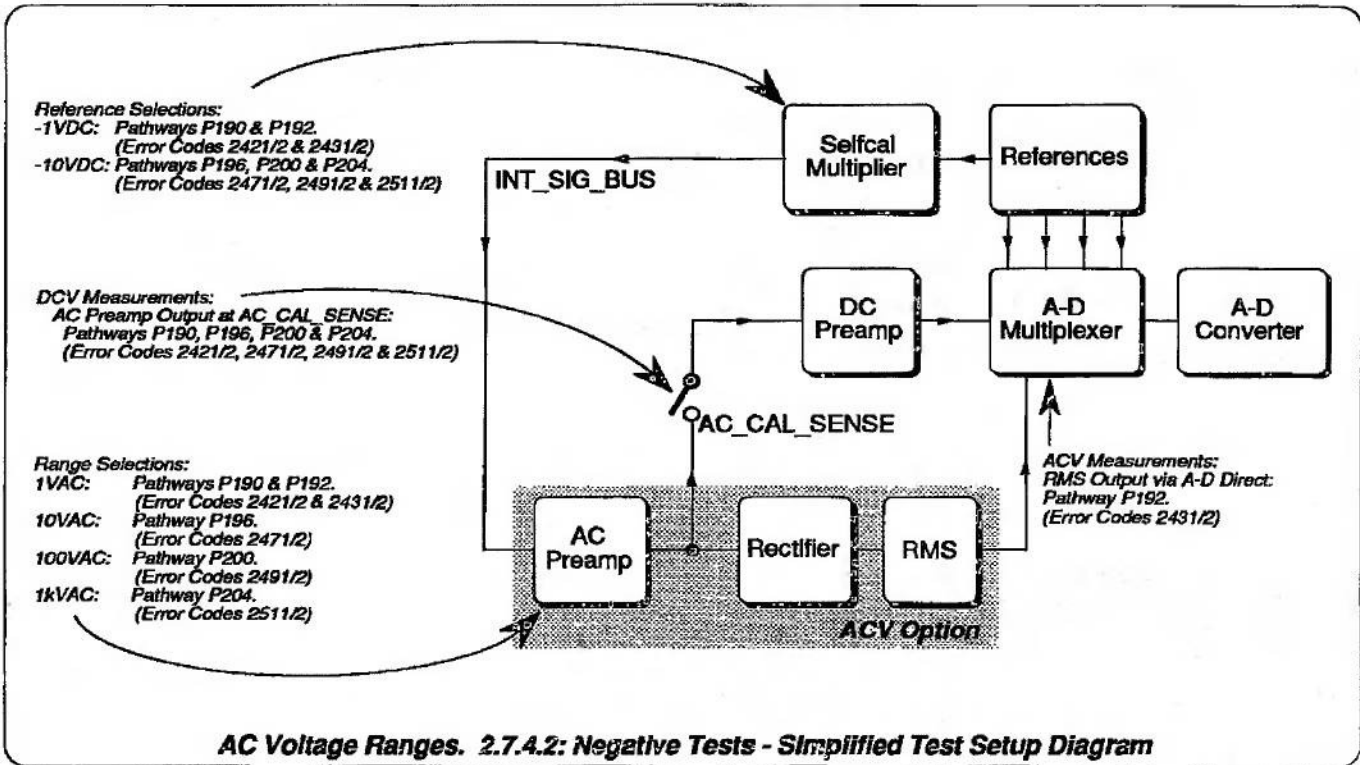

Volumes 2 References

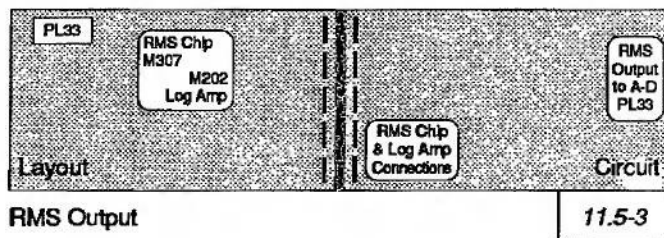
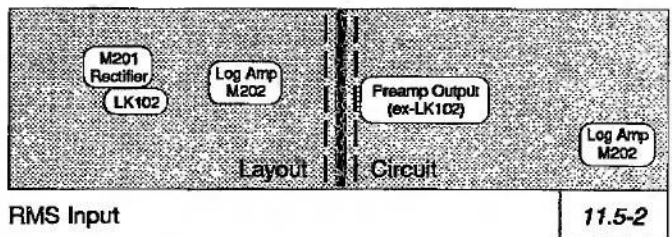
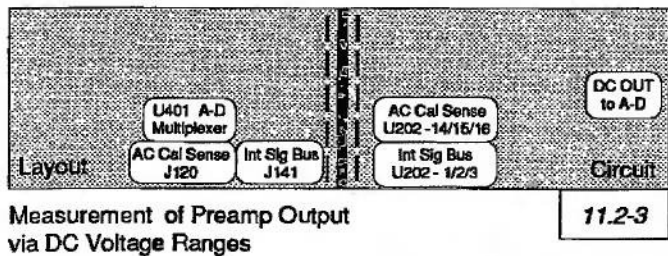
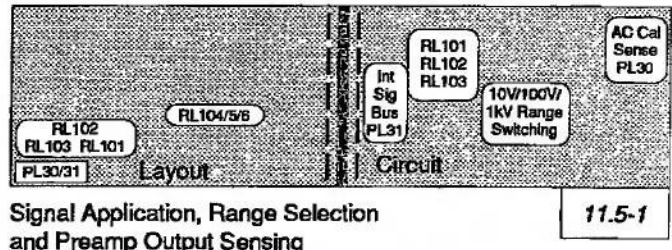
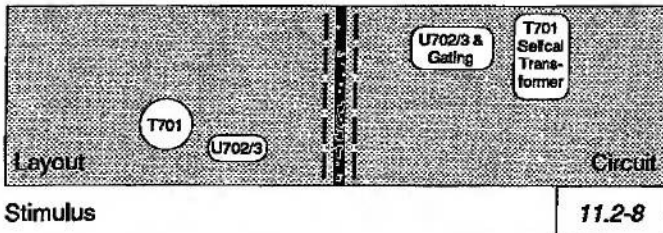

## List of AC Voltage Measurements (Contd.)

## 7.4.2 Negative Tests

## 1V AC Range

- P190 **-1V DC Input - Checks at AC Preamp Output**  
 Input: -1VDC to AC Preamp set to 1VAC Range.  
 Measure: Preamp Output using 1V DC Range at AC\_CAL\_SENSE.  
 No. of Readings: 24 Discarded; 8 Processed.
- 2421 Preamp Output Noise      Standard Deviation  $\leq$  10000ppm  
 2422 Preamp Output Magnitude     $+0.96 < \text{Mean Signal} < +1.04$
- P192 **-1V DC Input - Checks at RMS Converter Output**  
 Input: -1VDC to AC Preamp set to 1VAC Range. Measure: RMS Output via A-D.  
 No. of Readings: 24 Discarded; 8 Processed.
- 2431 RMS Output Noise      Standard Deviation  $\leq$  10000ppm  
 2432 -RMS Output Magnitude     $0.96 < \text{Mean Signal} < 1.04$

## 10V AC Range

- P196 **-10V DC Input - Checks at AC Preamp Output**  
 Input: -10VDC to AC Preamp set to 10VAC Range.  
 Measure: Preamp Output using 1V DC Range at AC\_CAL\_SENSE.  
 No. of Readings: 24 Discarded; 8 Processed.
- 2471 Preamp Output Noise      Standard Deviation  $\leq$  10000ppm  
 2472 Preamp Output Magnitude     $+0.94 < \text{Mean Signal} < +1.04$

## 100V AC Range

- P200 **-10V DC Input - Checks at AC Preamp Output**  
 Input: -10VDC to AC Preamp set to 100V AC Range.  
 Measure: Preamp Output using 100mV DC Range at AC\_CAL\_SENSE.  
 No. of Readings: 24 Discarded; 8 Processed.
- 2491 Preamp Output Noise      Standard Deviation  $\leq$  10000ppm  
 2492 Preamp Output Magnitude     $+0.94 < \text{Mean Signal} < +1.04$

## 1kV AC Range

- P204 **-10V DC Input - Checks at AC Preamp Output**  
 Input: -10VDC to AC Preamp set to 1kV AC Range.  
 Measure: Preamp Output using 100mV DC Range at AC\_CAL\_SENSE.  
 No. of Readings: 24 Discarded; 8 Processed.
- 2511 Preamp Output Noise      Standard Deviation  $\leq$  10000ppm  
 2512 Preamp Output Magnitude     $+0.1862397 < \text{Mean Signal} < +0.2017596$



2.7.5 DC Current Tests

Test Setup Model

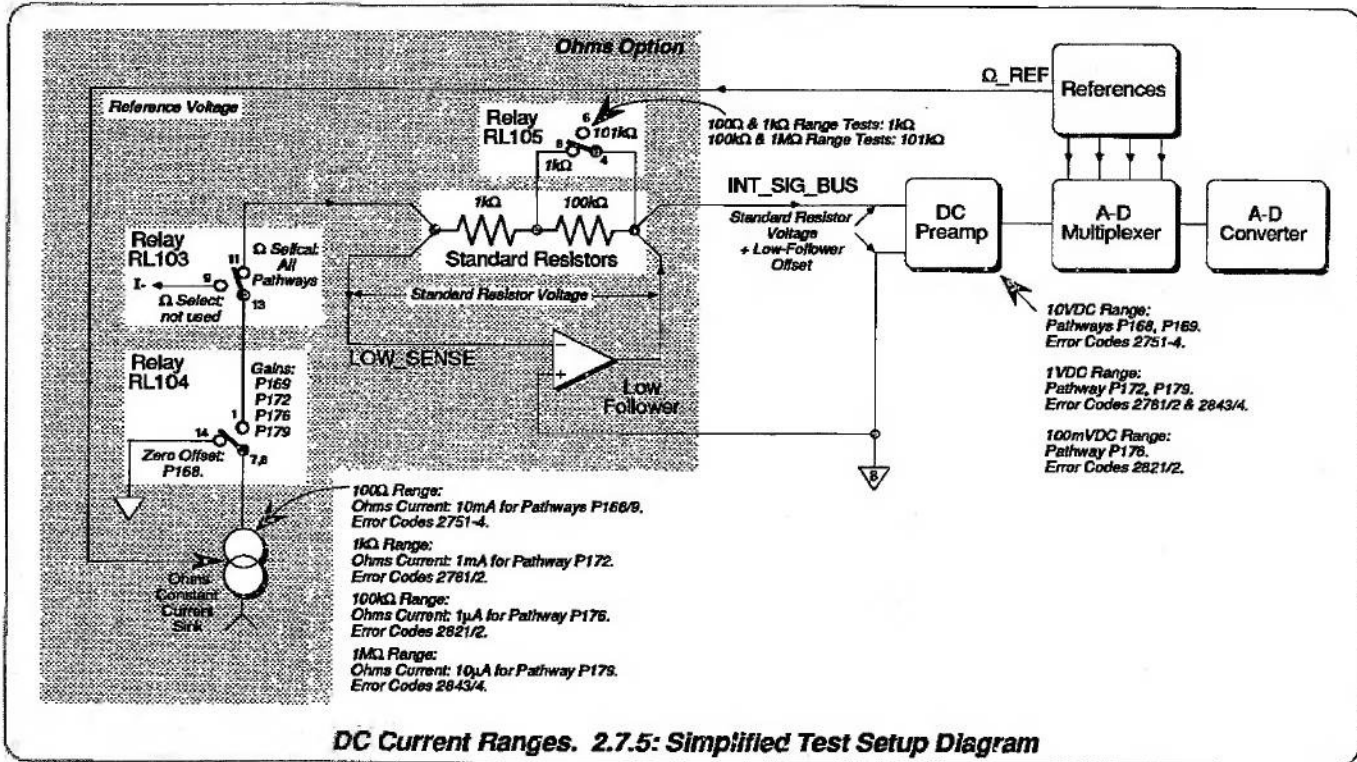

Volume 2 References

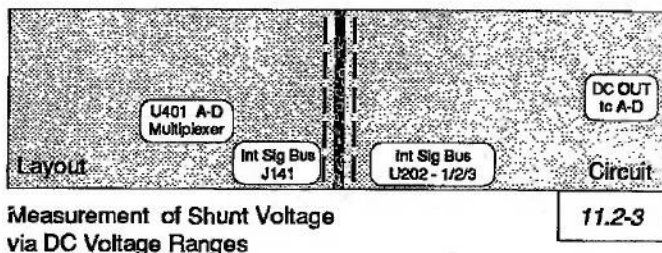
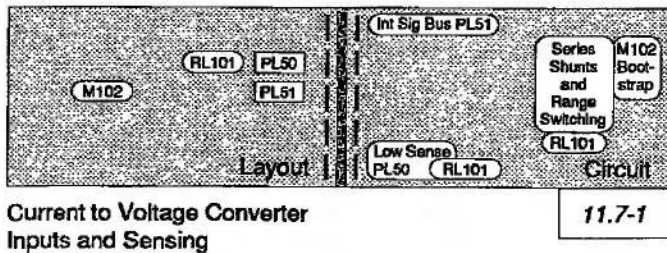
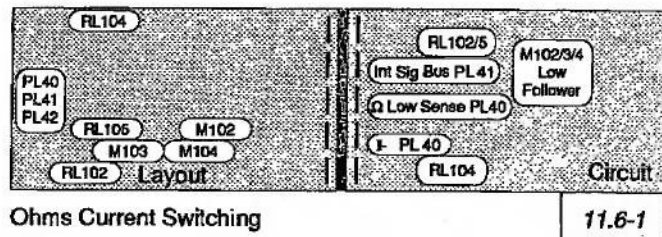
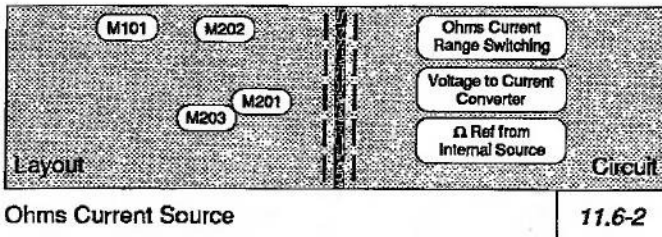



## List of DC Current Measurements

## 10mA DC Range

## P212 Gain Checks

Inputs: 10mA Ohms Current via LOW\_SENSE; 10mA Selfcal Current Selected.

Measure: 10mA DC Range Shunt value using 100Ω Normal Ohms Range.

No. of Readings: 4 Discarded; 8 Processed.

2531	Range Gain Noise	Standard Deviation ≤ 10000ppm
2532	Range Gain Magnitude	+0.96 < Mean Magnitude < +1.04

## 100mA DC Range

## P214 Gain Checks

Inputs: 10mA Ohms Current via LOW\_SENSE; 100mA Selfcal Current Selected.

Measure: 100mA DC Range Shunt value using 100Ω Normal Ohms Range.

No. of Readings: 4 Discarded; 8 Processed.

2551	Range Gain Noise	Standard Deviation ≤ 10000ppm
2552	Range Gain Magnitude	+0.096 < Mean Magnitude < +0.104

## 1A DC Range

## P216 Gain Checks

Inputs: 10mA Ohms Current via LOW\_SENSE; 1A Selfcal Current Selected.

Measure: 1A DC Range Shunt value using 100Ω Normal Ohms Range.

No. of Readings: 4 Discarded; 8 Processed.

2571	Range Gain Noise	Standard Deviation ≤ 10000ppm
2572	Range Gain Magnitude	+0.0094 < Mean Magnitude < +0.0106

## 1mA DC Range

## P218 Gain Checks

Inputs: 1mA Ohms Current via LOW\_SENSE; 1mA Selfcal Current Selected.

Measure: 1mA DC Range Shunt value using 100Ω Lol Ohms Range.

No. of Readings: 4 Discarded; 8 Processed.

2591	Range Gain Noise	Standard Deviation ≤ 10000ppm
2592	Range Gain Magnitude	+0.96 < Mean Magnitude < +1.04

## 100μA DC Range

## P220 Gain Checks

Inputs: 100μA Ohms Current via LOW\_SENSE; 100μA Selfcal Current Selected.

Measure: 100μA DC Range Shunt value using 1kΩ Lol Ohms Range.

No. of Readings: 4 Discarded; 8 Processed.

2611	Range Gain Noise	Standard Deviation ≤ 10000ppm
2612	Range Gain Magnitude	+0.96 < Mean Magnitude < +1.04

Test Setup Model

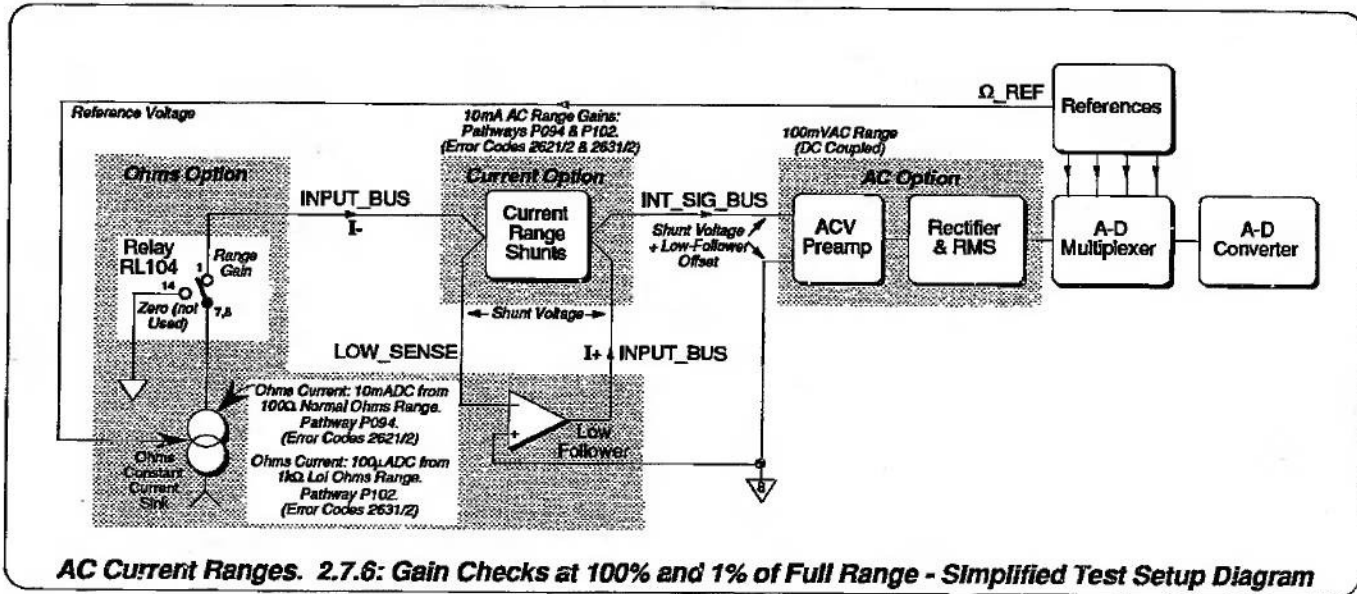

Volume 2 References

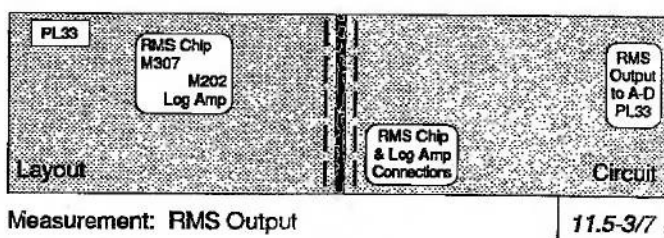
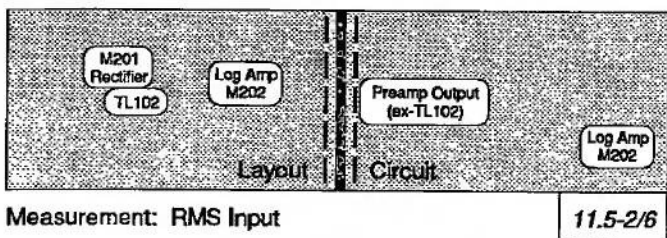
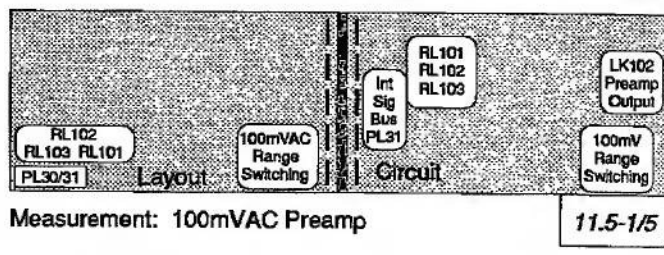
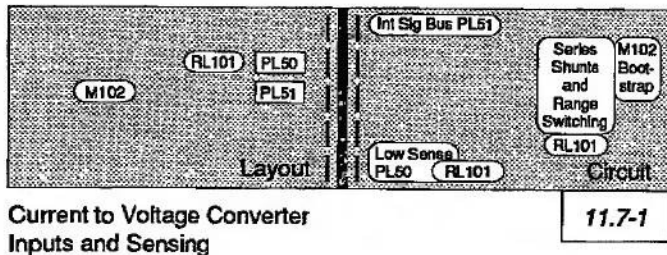
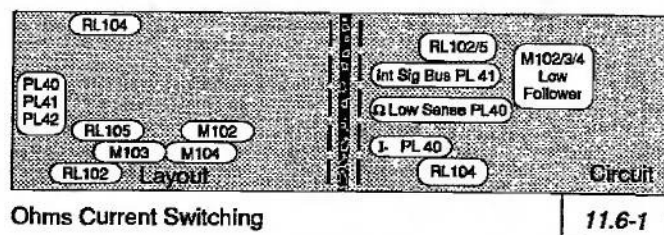
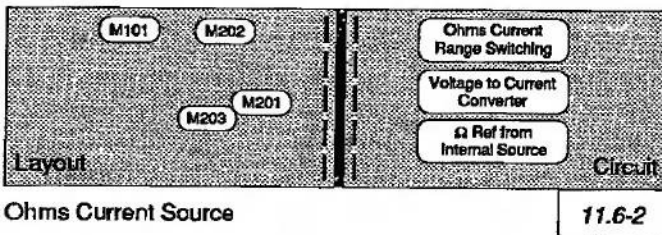



## List of AC Current Measurements

## 10mA AC Range

## P094 10mA AC Range - Gain Checks

Inputs: 10mA Ohms Current via LOW\_SENSE; 10mA Selfcal Current Selected.

Measure: 10mA Range Gain using 100Ω Normal Ohms Range (using 100mV AC Range and A-D).

No. of Readings: 8 Discarded; 8 Processed.

2621 Range Gain Noise Standard Deviation  $\leq 10$ ppm of FS2622 Range Gain Magnitude  $+0.93 < \text{Mean Magnitude} < +1.07$ 

## P102 10mA AC Range - AC Zero Checks (AC Zero is 1% FS)

Inputs: 100μA Ohms Current via LOW\_SENSE; 10mA Selfcal Current Selected.

Measure: 10mA Range Zero using 1kΩ Lol Ohms Range (using 100mV AC Range and A-D).

No. of Readings: 8 Discarded; 8 Processed.

2631 Range Zero Noise Standard Deviation  $\leq 10$ ppm of FS2632 Range Zero Magnitude  $+0.01 < \text{Zero} < +0.04$

2.7.7 Resistor Ratio Tests

Test Setup Model

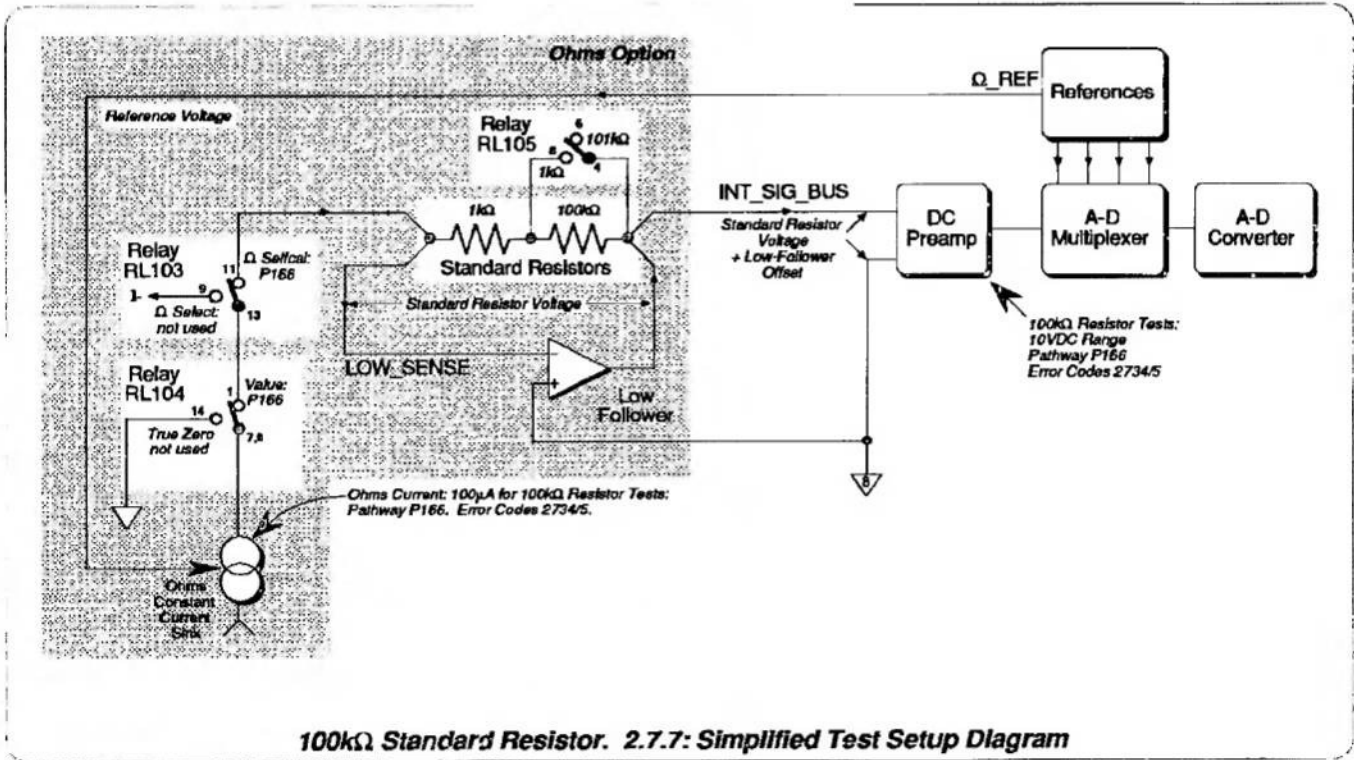

Volume 2 References

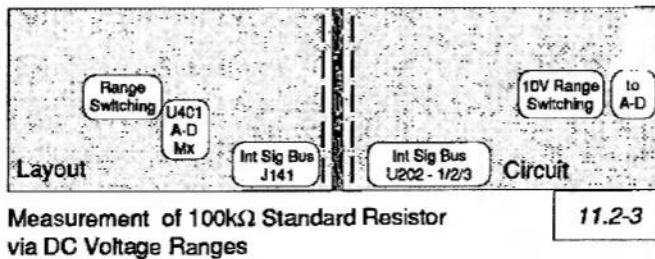
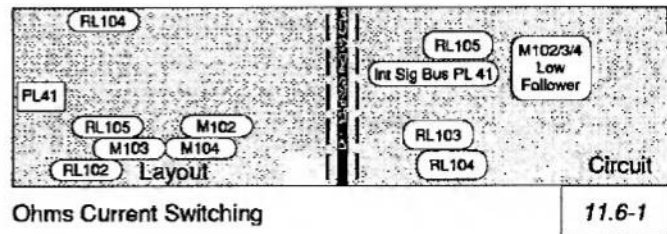
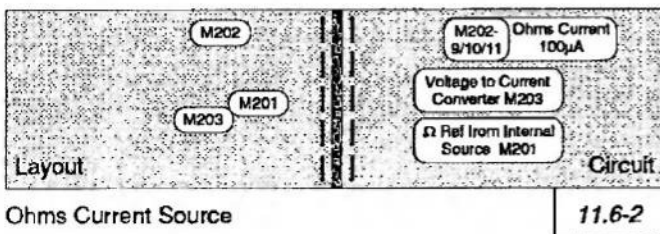



List of Resistor Ratio Measurements

10kΩ Standard Resistor

- P166 100kΩ Standard Resistor Value  
Ohms Current: 100μA. DCV Range: 10V. No. of Readings: 8 Discarded; 6 Processed.
- 2734 Noise Standard Deviation < 500ppm
- 2735 Magnitude +0.98 < Magnitude < +1.02

2.7.8 Ohms Tests

Test Setup Model

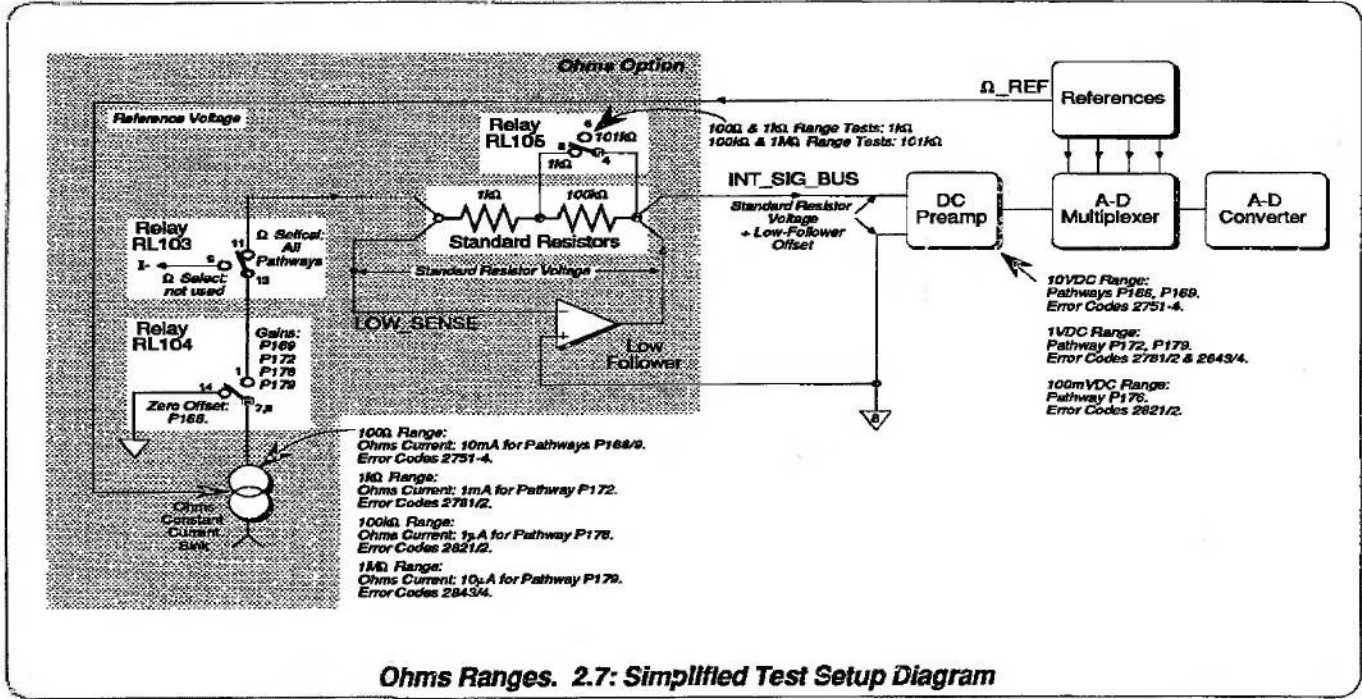

Volume 2 References

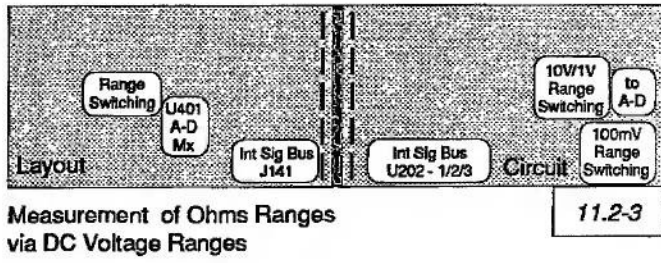
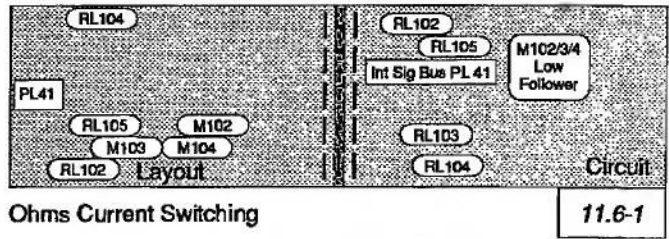
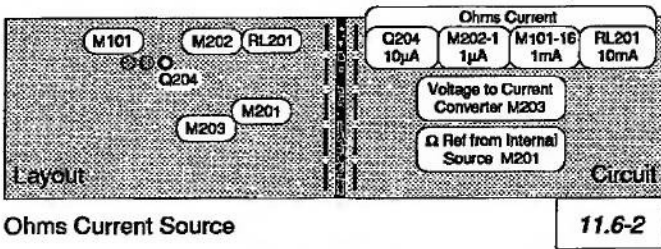



## List of Ohms Measurements

10 $\Omega$  Range

- P168 **100 $\Omega$  Range Zero** (Measured using the 10V DC Range)  
 Ohms Current: True Zero (10mA selected). Standard Resistor: 1k $\Omega$ . DCV Range: 10V.  
 No. of Readings: 8 Discarded; 6 Processed.
- 2751 Noise Standard Deviation  $\leq$  500ppm
- 2752 Magnitude  $-200\text{ppm} < \text{Mean Magnitude} < +200\text{ppm}$

- P169 **100 $\Omega$  Range Gain** (Measured using the 10V DC Range)  
 Ohms Current: 10mA. Standard Resistor: 1k $\Omega$ . DCV Range: 10V.  
 No. of Readings: 8 Discarded; 6 Processed.
- 2753 Noise Standard Deviation  $\leq$  500ppm
- 2754 Magnitude  $+0.96 < \text{Mean Magnitude} < +1.04$

1k $\Omega$  Range

- P172 **1k $\Omega$  Range Gain** (Measured using the 1V DC Range)  
 Ohms Current: 1mA. Standard Resistor: 1k $\Omega$ . DCV Range: 1V.  
 No. of Readings: 8 Discarded; 6 Processed.
- 2781 Noise Standard Deviation  $\leq$  500ppm
- 2782 Magnitude  $+0.96 < \text{Mean Magnitude} < +1.04$

100k $\Omega$  Range

- 76 **100k $\Omega$  Range Gain** (Measured using the 100mV DC Range)  
 Ohms Current: 1 $\mu$ A. Standard Resistor: 100k $\Omega$ . DCV Range: 100mV.  
 No. of Readings: 8 Discarded; 6 Processed.
- 2821 Noise Standard Deviation  $\leq$  500ppm
- 2822 Magnitude  $+0.96 < \text{Mean Magnitude} < +1.04$

1M $\Omega$  Range

- P179 **1M $\Omega$  Range Gain** (Measured using the 1V DC Range)  
 Ohms Current: 10 $\mu$ A. Standard Resistor: 100k $\Omega$ . DCV Range: 1V.  
 No. of Readings: 8 Discarded; 6 Processed.
- 2843 Noise Standard Deviation  $\leq$  500ppm
- 2844 Magnitude  $+0.96 < \text{Mean Magnitude} < +1.04$

## SECTION 3 DISMANTLING AND REASSEMBLY

This section contains information and instructions for dismantling the Datron 1271 to PCB level. Reassembly is generally the reverse dismantling, but where necessary, additional notes are given.

### 3.1 General Precautions

#### 3.1.1 WARNING

ISOLATE THE INSTRUMENT FROM THE LINE SUPPLY BEFORE ATTEMPTING ANY DISMANTLING OR REASSEMBLY.

#### 3.1.2 CAUTIONS

1. REMOVAL OF EITHER THE TOP OR BOTTOM COVER INVALIDATES THE MANUFACTURER'S CALIBRATION CERTIFICATION.
2. HANDLE THE INSTRUMENT CAREFULLY WHEN PARTIALLY DISMANTLED, TO AVOID SHAKING UNSECURED ITEMS LOOSE.
3. DO NOT TOUCH THE CONTACTS OF ANY PCB CONNECTORS.  
ENSURE THAT NO WIRES ARE TRAPPED WHEN FITTING COMPONENTS, ASSEMBLIES OR COVERS.
5. DO NOT ALLOW WASHERS, NUTS, ETC. TO FALL INTO THE INSTRUMENT.

### 3.2 General Mechanical Layout

Assembly Drawings in Volume 2, Section 11, pages 11.1-1 to 11.1-9; show how the 1271 is broken down into sub-assemblies.

#### 3.2.1 Front Panel

The Front Panel layout is illustrated in the User's Handbook, Section 3, Page 3-1.

Six labelled terminals are provided in a block at the left side of the panel, for connection to the source being measured.

Two plasma displays are mounted side-by-side. The left-hand display shows the measurement reading, and the activity symbols for the keys beneath the screen. The right-hand display presents menus as selected by the menu keys below it, showing instrument current-status information.

Two banks of pushbutton switches are provided to control the instrument's operation. For each switch, some indication of the action of pressing the switch is given on one of the two displays.

The line power is turned on and off by a toggle pushbutton on the extreme right side of the Front Panel.

#### 3.2.2 Rear Panel

*(All directions viewing from the rear of the instrument)*

The Rear Panel Layout is illustrated and described in the User's Handbook, Section 2, Page 2-3.

Selection of Line Voltage and Frequency are described in the User's Handbook, Section 2, Page 2-4: 'Preparation for Operation'.

Bench and Rack Mounting methods appear in the User's Handbook, Section 2, Page 2-6: 'Mounting'.

Electrical Connectors, are described in the User's Handbook, Section 2, Page 2-8: 'Connectors and Pin Designations'.



## 3.3 Location and Access

### 3.3.1 External Construction

Both the front and rear panels are joined by two side extrusions running from front to rear. These extrusions provide slots for the handles or rack mounting 'ears'. The bottom cover is fitted with the tilt-stand and four rubber feet. Ground screening of the covers is provided by aluminium plates fitted to the inside of the covers; the main ground connection being made to the rear panel. Each cover also has a guard screen which shields the sensitive input circuits from common-mode disturbances; these connect to the guard enclosure in the front partition to form an effective guard box. The top cover guard screen is partly cut away to enhance internal air circulation.

### 3.3.2 Internal Construction

Inside the covers, mechanical strength is provided by the two side extrusions, separated and secured by two cross supports - the rear panel plate, and a similar plate at the front - which together form a rigid box-section. An internal cross support divides the interior of the instrument into front and rear partitions:

#### Interior Partitions

- The **Rear Partition** is occupied by a sub-chassis screwed to both the rear panel metalwork and the internal cross support. Mains (Line) and Low-Voltage transformers are secured to the underside, and external electrical connections pass through the rear of the sub-chassis.

On the upper sub-chassis, nylon slides locate the Digital PCB Assembly, which fits at the front into polycarbonate mounts on the main cross support and with screws securing the assembly to the rear panel metalwork. A Mylar sheet glued to the top of the sub-chassis provides insulation for the joints on the underside of the digital assembly. External electrical connections to the digital assembly pass through the rear panel metalwork, which is also used as an additional heatsink for four transistors.

- The **Front Partition** contains the Guard Shield Assembly, attached by five polycarbonate insulators to the front panel metalwork and internal cross support. The assembly is divided into upper and lower spaces by a horizontal plate.

The DC PCB Assembly is mounted on top of the plate; the optional AC, Ohms and Current Assemblies are mounted on the underside. The AC Assembly is screwed to the plate, but the DC, Ohms and Current Assemblies are fixed by Nylatch press fasteners.

- **Connecting Cables** between the various assemblies pass through cut-outs in the metalwork, and are loomed and secured where necessary.

#### Front Extension

The instrument extends forward from the main box section to accommodate the front panel components. Externally it is enclosed by a structural-foam bezel, complete with display filters, terminal labels and apertures for the banks of press-button switches. The bezel is secured to the front cross support by two screws at each end, which are accessible from the sides of the instrument once the top and bottom covers have been removed.

When the bezel is removed:

- The **Switch Assembly** is mechanically secured to the rear of the bezel, but electrically connected by two cables to two sockets on the component side of the Display PCB. This assembly does not include the Power On/Off switch.
- The **Power On/Off Switch Assembly** is secured by two screws to the rear of the right side extrusion, beneath the sub-chassis. The switch itself being operated by a cranked moulding fitted inside the extrusion slide. The switch action is 'Push On - Push Off'.

A rod in the moulding extends to the front of the extrusion, where a second cranked moulding connects it to the front panel On/Off pushbutton. The button is a tight push-fit, and not cemented to the moulding, so that it does not prevent the bezel from being removed. The location of the switch is adjusted so that the pushbutton is flush with the bezel when in the 'Off' position, and depressed into the bezel when power is switched 'On'.

- The **Display PCB Assembly** is screwed to the front cross support. It carries the two plasma displays which are viewed through the filters in the bezel. A metal screen on the left end of the assembly shields the signals on the front panel terminals from the high voltage pulses which drive the displays.
- The **Front Panel Terminal Assembly** is secured by two screws to a structural-foam sliding mount which forms part of a latching mechanism inside the left side extrusion, with the terminals protruding forward of the bezel when required for use.

A rod from the rear of the mechanism connects to a 'Terminal Release' button on the Rear Panel. To avoid damage during transportation, the terminals are retracted by pressing and holding the button in, while pushing the terminal assembly in against spring pressure until they are flush with the front of the bezel. Releasing the button latches the terminal assembly into the retracted position.

To release the terminals for use, they should be held against the spring pressure while pressing the release button, and allowed to move forward gently until fully extended. The button is then released to secure a latch in the extended position.



### 3.4 General Access

ENSURE THAT POWER IS OFF.

- Heed the General Precautions 3.1.1 and 3.1.2.

If, during a procedure, sufficient access has been obtained, then no further dismantling is required.

#### 3.4.1 Rear Corner Blocks, Top Cover

##### • Removal

**Caution!** This operation invalidates the manufacturer's calibration certification!

- a. Remove each of the two rear corner blocks by undoing its single crosspoint screw.
- b. Release the two spring-loaded screws holding the cover to the rear panel.
- c. Slide the cover to the rear until:
  - i. The small locating tongue on the rear of the top ground shield disengages from the rear panel.
  - ii. The cover front flange clears the bezel.
- d. Lift off the cover.

##### • Fitting

- a. Locate the cover on the top rails of the side extrusions, its front flange just behind the bezel.
- b. Press down on the cover and slide it forward until:
  - i. The cover front flange slides under the bezel.
  - ii. The small locating tongue on the rear of the top ground shield engages into the rear panel.
- c. Tighten the two spring-loaded screws to secure the cover to the rear panel.
- d. Refit each of the two rear corner blocks by securing its single crosspoint screw.

#### 3.4.2 Rear Corner Blocks, Bottom Cover

##### • Removal

**Caution!** This operation invalidates the manufacturer's calibration certification!

- a. Remove each of the two rear corner blocks by undoing its single crosspoint screw.
- b. With the instrument inverted, release the two spring-loaded screws holding the bottom cover to the rear panel slot.
- c. Slide the cover to the rear until:
  - i. The small locating tongue on the rear of the bottom ground shield disengages from the rear panel.
  - ii. The cover front flange clears the bezel.
- d. Lift off the cover.

##### • Fitting

- a. With the instrument inverted, locate the bottom cover on the bottom rails of the side extrusions, its front flange just behind the bezel.
- b. Press down on the cover and slide it forward until:
  - i. The cover front flange slides under the bezel.
  - ii. The small locating tongue on the rear of the bottom ground shield engages into the rear panel slot.
- c. Tighten the two spring-loaded screws which secure the cover to the rear panel.
- d. Refit each of the two rear corner blocks by securing its single crosspoint screw.

### 3.4 General Access (Contd.)

#### 3.4.3 Front Bezel

- Remove rear corner blocks, top and bottom covers: 3.4.1 and 3.4.2.
- **Removal**  
(Facing page 11.1-1, DA400891 Sh. 1)
  - a. Retract the front panel Input terminals by pressing and holding the rear panel Terminal Release button in, while pushing the terminal assembly in against spring pressure until they are flush with the front of the bezel. Release the button - this latches the terminal assembly into the retracted position..
  - b. Remove the four M2.5 x 6mm Pozi-pan screws holding the bezel to the side extrusions, each with its two spring washers (nylon spacers in early versions).
  - c. Gently withdraw the bezel from the body of the instrument, taking care to retain the power switch key cap, which is a push fit onto its cranked moulding, and comes away with the bezel. **Do not** attempt to prize the Power key cap out of its recess before removing the bezel - it detaches easily with the bezel. Do not strain the two ribbon cables connecting the Switch PCB to the Display PCB.
- **Fitting**

Reverse the removal procedure, taking heed of the references at each stage. Be careful not to trap any wiring. Before finally tightening the four Pozi-pan screws, adjust the position of the bezel so that the Power Switch key cap is flush with the front panel when in the Off position, and operate the retraction mechanism to ensure that the terminals move freely. Tighten down the screws and make a final inspection to ensure that the ribbon cable and mechanical elements are correctly fitted and secured.

#### 3.4.4 Rear Panel Assembly

*N.B.* For most purposes it should not be necessary to remove the Rear Panel Assembly. However, it is necessary when the Digital PCB Assembly is to be taken out. It can be easier to remove the Rear panel and Digital board together, and separate the two later, than to remove the panel first. Two procedures are given, the first to remove the panel on its own (in this sub-section), and the second to remove the Digital assembly (in sub-section 3.5.1).

- Remove rear corner blocks, top and bottom covers: 3.4.1 and 3.4.2.
- **Removal of Rear Panel Only**  
(Facing page 11.1-3, DA400892 Sh. 1)
  - a. Remove the eight M3 x 8mm Pozi-pan screws which attach the Rear Panel to the sub-chassis and digital assembly.
  - b. Remove the four M3 x 8mm Pozi-countersunk screws which secure the Rear Panel to the side extrusions.
  - c. Gently ease the rear panel away from the body of the instrument and remove.
- **Fitting**

Offer up the rear panel to the body of the instrument and locate the Terminal Release button in its slot.

Reverse the removal procedure, taking heed of the references at each stage. Be careful not to trap any wiring. Make a final inspection to ensure that the wiring is correctly fitted and secured.



## 3.5 Sub-Assembly Removal and Fitting

### 3.5.1 Digital PCB Assembly

- Remove rear corner blocks, top and bottom covers: 3.4.1 and 3.4.2.
- Stand the instrument in its normal upright position. Ensure that the Calibration Enable key is removed from its lock.

#### 3.5.1.1 Removal of combined Rear Panel and Digital PCB Assembly

- a. Carefully remove the three 3M multiconnector sockets from PL1, PL2 and PL3 on the right front corner of the Digital Assembly.

*Note: The 3M ribbon socket has a rectangular key, which locates into a recess in the fixed plug shroud, leaving a small slot into which a small screwdriver blade can be inserted and twisted to lever off the socket easily.*

- b. Carefully remove the three Molex multiconnector sockets from PL4, PL5 and PL6 on the right end of the Digital Assembly.
- c. Remove the three M3 x 8mm Pozi-pan screws which attach the Rear Panel to the sub-chassis.
- d. Remove the four M3 x 8mm Pozi-countersunk screws which secure the Rear Panel to the side extrusions.
- e. Gently ease the rear panel and digital assembly away from the body of the instrument until it is just clear of the Terminal Release button. While holding the button to one side to clear the components on the digital assembly, carefully slide the combined rear panel and digital assembly to the rear, and remove.

#### • Fitting

- a. Locate the Digital Assembly PCB into the nylon slides fitted to the sub-chassis.
- b. Reverse the removal procedure, ensuring that the terminal release button does not foul the digital assembly components. Slide the combination forward, until the digital assembly is fully home between the tongues of the three polycarbonate mounts on the cross support. Ensure that the right upper rear countersunk screw is fitted into the eye of the bonding strap for the digital assembly heatsink, to trap it between the rear panel and side extrusion. Be careful not to trap any other wiring.
- c. Make a final inspection to ensure that the wiring, ribbon cables and sockets are correctly fitted and secured.

#### 3.5.1.2 Separating the Removed Rear Panel and Digital PCB Assembly

##### • Separation

Remove the five M3 x 8mm Pozi-pan screws which attach the Rear Panel to the Digital Assembly, and carefully separate the two.

##### • Recombination

Reverse the separation procedure.

### 3.5 Sub-Assembly Removal and Fitting (Contd.)

#### 3.5.2 Display PCB

- Remove rear corner blocks, top and bottom covers: 3.4.1 and 3.4.2.
- Remove the Front Bezel: 3.4.3.
- **Removal**  
(Facing page 11.1-3, DA400892 Sh. 1)
  - a. Disconnect the two eight-way ribbon connectors from PL22 and PL23 (From the Switch Assembly in the Bezel) on the front of the Display PCB. Note the correct positions for later return (See also the facing page 11.8-1, 480744 Sh. 1)
  - b. Remove the Bezel and Switch Assembly.
  - c. At the right end of the display assembly, pull the cranked moulding off the Power Switch operating rod.
  - d. Disconnect the two 3M ribbon connectors from PL20 and PL21 on the front of the Display PCB.  
*Note: The 3M ribbon socket has a rectangular key, which locates into a recess in the fixed plug shroud, leaving a small slot into which a small screwdriver blade can be inserted and twisted to lever off the socket easily.*
  - e. Remove the Three M3 x 8mm Pozi-pan screws which attach the Display Assembly to standoffs on the Front Panel metalwork.
  - f. Disengage the Display Assembly from the four black retainers on the top of the front panel metalwork, and carefully remove.
- **Fitting**

Reverse the removal procedure. Be careful not to trap any wiring. Make a final inspection to ensure that the wiring and ribbon cables are correctly fitted and secured.

#### 3.5.3 Front Panel Switch PCB Assembly

- Remove rear corner blocks, top and bottom covers: 3.4.1 and 3.4.2.
- Remove the Front Bezel: 3.4.3.
- **Removal**  
(Facing page 11.1-6, 480745 Sh. 1)
  - a. Lay the Bezel face down, so that the rear of the Switch Assembly is accessible.
  - b. Remove the two M3 x 6mm screws, each with its shakeproof and plain washer, which attach the assembly to the bezel at the right end of the switch assembly.
  - c. Remove the two M3 x 12mm screws, each with its shakeproof and plain washer, which attach the assembly to the bezel through the support bar running across the rear of the assembly.
  - d. Carefully lift the switch assembly, complete with key caps, from the bezel. The key caps should slide easily through their two apertures.
- **Fitting**

Ensure that the key caps are correctly fitted. Reverse the removal procedure. Make a final inspection to check that the key caps are correctly oriented.



### 3.5.4 Front Terminal Assembly

- Remove rear corner blocks, top and bottom covers: 3.4.1 and 3.4.2.
- Remove the Front Bezel: 3.4.3.
- Removal**  
(Facing page 11.1-1, Drawing DA400891 Sh. 1)  
(Facing page 11.1-9, Drawing 480770 Sh. 1)  
(Facing page 11.2-1, Drawing DA400866 Sh. 1)
  - a. Stand the instrument in its normal upright position.
  - b. Remove the M3 Pozi-pan screw which attaches the Terminal Assembly flexible PCB to the front left of the DC PCB.
  - c. Disconnect the flexible pcb from J100/101/102 on the DC PCB.
  - d. Remove the two M2.5 x 6mm Pozi-csk screws which attach the terminal assembly to the retraction mechanism without kinking.
  - e. Remove the terminal assembly, carefully feeding the flexible PCB through the hole in the front panel metalwork.
- Fitting**
  - a. Reverse the removal procedure, being careful to avoid kinking the flexible PCB when threading it through the hole.
  - b. When refitting the bezel, it may be necessary to adjust the position of the assembly to ensure free movement of the retraction mechanism.

### 3.5.5 DC PCB Assembly

- Remove rear corner blocks and top cover: 3.4.1.
- Removal**  
(Facing page 11.1-1, Drawing DA400891 Sh. 1)  
(Facing page 11.2-1, Drawing DA400866 Sh. 1)  
(Facing page 11.4-2, Drawing DA400901 Sh. 1)
  - a. Stand the instrument in its normal upright position.
  - b. Remove the M3 Pozi-pan screw which attaches the Terminal Assembly flexible PCB to the front left of the DC PCB.
  - c. Disconnect the flexible pcb from J100/101/102 on the DC PCB.
  - d. Disconnect the 3M ribbon cable socket from PL3 on the Digital PCB (This cable is soldered at the DC PCB end as J110).
  - e. Disconnect the three 3M ribbon cable sockets from J105, J107 and J109 on the DC PCB.
  - f. Disconnect the Molex cable socket from J103 on the DC PCB.
  - g. Disconnect the 'Channel A Input' Molex cable sockets from J150/151/152 at the left rear of the DC PCB. Note the positions of these cables for correct refitting later.
  - h. Disconnect the 'Channel B Input' Molex cable sockets from J160/161/162 next to the Channel A plugs at the left rear of the DC PCB. Note the positions of these cables for correct refitting later.
  - j. Disconnect the Molex cable sockets from J120/121/122 at the center front of the DC PCB (AC PCB Assembly connections).
  - k. Disconnect the Molex cable sockets from J130/131/132 at the center-right front of the DC PCB (Ohms PCB Assembly connections).
  - l. Disconnect the Molex cable sockets from J140/141/142 at the right front of the DC PCB (Current PCB Assembly connections).  
Note: In early instruments, two fly-leads from the Current Assembly are laid around the DC PCB and connected to two plugs: J111 and J143 on the DC PCB. Disconnect the sockets at these plugs also.
  - m. Release the DC PCB Assembly by removing eleven M3 X 8 pozipan screws.
  - n. Gently lift the DC PCB Assembly out of the Guard Box, taking care not to damage any cables or components, and remove.
- Fitting**  
Reverse the removal procedure, being careful not to trap any wiring. Make a final inspection to ensure that the cable sockets are connected to the correct plugs, paying particular attention to the 'Channel A Input' and 'Channel B Input' sockets.

## 3.5 Sub-Assembly Removal and Fitting (Contd.)

### 3.5.6 AC PCB Assembly

**Note:** The cutaway guard shield (which partially covers the AC PCB Assembly) is secured to four nylon pillars which themselves attach the AC PCB to the guard box. The shield must therefore be removed to access these pillars, before removing the PCB.

- Remove rear corner blocks and bottom cover: 3.4.2.
- **Removal**  
(Page 11.1-1, DA400891 Sh. 2)  
(Facing page 11.5-1, DA400870 Sh. 1)
  - a. Ensure that the instrument is inverted.
  - b. Disconnect the 3M ribbon cable socket from PL33 at the rear of the AC PCB.
  - c. Disconnect the Molex cable sockets from PL30/31/32 at the front of the AC PCB.
  - d. Remove the eight M3 Pozi-countersunk screws which attach the Guard shield.
  - e. Using a wide-bladed screwdriver, remove the four nylon standoff pillars which support the Guard shield, and which also attach the AC PCB to the guard box (the four bright metal posts are swaged to the PCB and do not need to be removed).
  - f. Remove the four M3 x 8mm Pozi-pan screws and wavy washers which attach the AC PCB Assembly to the Guard Box, and remove the PCB.
- **Fitting**  
Reverse the removal procedure, being careful not to trap any wiring.

### 3.5.7 Ohms PCB Assembly

- Remove rear corner blocks and bottom cover: 3.4.2.
- **Removal**  
(Page 11.1-1, DA400891 Sh. 2)  
(Facing page 11.6-1, 480742 Sh. 1)
  - a. Ensure that the instrument is inverted.
  - b. Disconnect the 3M ribbon cable socket from PL43 at the rear of the Ohms PCB.
  - c. Disconnect the Molex cable sockets from PL40/41/42 at the front of the Ohms PCB.
  - m. Release the Ohms PCB Assembly by lifting the five black Nylatch press fasteners.
  - n. Gently lift the Ohms PCB Assembly out of the Guard Box, taking care not to damage any cables or components, and remove.
- **Fitting**  
Reverse the removal procedure, being careful not to trap any wiring.



### 3.6 Front Terminal Retraction Mechanism

It is not recommended that this mechanism be adjusted, removed or replaced except by Datron's service representatives, as it entails extensive dismantling.

In the unlikely event of mechanical failure, contact your nearest Datron Service Center (a list of representatives is given at the back of this handbook).

#### 5.8 Current PCB Assembly

- Remove rear corner blocks and bottom cover: 3.4.2.
- **Removal**  
(Page 11.1-1, DA400891 Sh. 2)  
(Facing page 11.7-1, 480743 Sh. 1)
  - a. Ensure that the instrument is inverted.
  - b. Disconnect the 3M ribbon cable socket from PL53 at the rear of the Current PCB.
  - c. Disconnect the Molex cable sockets from PL50/51/52 at the front of the Current PCB.  
Note: In early instruments, two fly-leads from the Current Assembly are laid around the DC PCB and connected to J111 and J143 on the DC PCB. Disconnect the sockets at these plugs and feed the two cables through the cable cutout before carrying out the next operation.
  - m. Release the Current PCB Assembly by lifting the five black Nylatch press fasteners.
  - n. Gently lift the Current PCB Assembly (and the two fly-leads and sockets if fitted) out of the Guard Box, taking care not to damage any cables or components, and remove.
- **Fitting**  
Reverse the removal procedure, being careful not to trap any wiring.

## 3.7 Transformer Assemblies

### 3.7.1 Mains Transformer Assembly

*(This Assembly includes the Power Switch and Voltage Selector Switch)*

**N.B.** To fit a mains transformer after removal, an M3 torque spanner capable of setting to 4Nm is required.  
For early versions: to refit requires a length of double-sided adhesive tape.

- Remove rear corner blocks, top and bottom covers: 3.4.1 and 3.4.2.
- Remove the Rear Panel: 3.4.4.

#### • Removal

*(Page 11.1-1, Drawing DA400891 Sh. 2)*

*(Facing page 11.1-4, Drawing DA400893 Sh. 1)*

*(Page 11.1-5, Drawing DA400893 Sh. 4)*

*(Facing page 11.1-8, Drawing 480749 Sh. 1)*

*(Facing page 11.4-2, Drawing DA400901 Sh. 1)*

- a. Ensure that the instrument is inverted.
- b. Identify the Mains Transformer, Power Switch and Voltage Selector Switch, in the right end of the sub-chassis at the rear of the instrument.
- c. Identify the green/yellow ground bonding lead from the mains transformer to the bonding point between the power input plug and the power fuse, on the sub-chassis.
- d. Remove the nut from the bonding point and remove the green/yellow lead identified in (c) above. Replace the nut to retain the other bonding leads.
- e. Turn the instrument to its upright position and disconnect the Molex socket of the mains transformer cable from PL5 (A & B) on the Digital PCB Assembly. Carefully feed the cable and socket back through the gap at the end of the sub-chassis, to the same side as the mains transformer.
- f. Return the instrument to its inverted position.
- g. Remove the two M3 nuts and shakeproof washers which attach the mains transformer to the sub-chassis studs.

*Note: In early versions the transformer is secured using long M3 countersunk screws, which are inserted from the upper side of the sub-chassis, and screwed into nuts encapsulated in epoxy resin in the transformer body. Access to the screwheads is more difficult in this case, as the digital assembly and the insulating card on the upper surface of the sub-chassis must be removed to expose the screwheads. Double-sided adhesive tape is required to secure the card after refitting a mains transformer.*

- h. Tip the instrument to stand on its right side and remove the mains transformer, laying it down on the bench so that the remaining wiring is not strained.
- j. Identify the Power Switch assembly located in the slider of the right side extrusion. Remove two M3 x 8mm Pozi-countersunk screws which secure the backplate to a retaining plate inside the extrusion slide.
- k. Lever the white operating bar of the power switch out of its cranked slider, and remove the switch.

- l. Slide back the sleeves on the blue and brown leads which are connected to the two end tags of the power switch. Note the positions and unsolder the leads from the tags.
- m. Identify the Voltage Selector Switch located at the rear of the sub-chassis. Remove two M3 x 8mm Pozi-countersunk screws, nuts and washers which secure the switch to the sub-chassis.
- n. Remove the two switches and the mains transformer.

#### • Fitting

- a. Reverse the dismantling procedure. Pay particular attention to the following points:
  - i. Solder the blue and brown leads to the correct power switch tags as noted in (l), and push the sleeves down to cover the joints completely.
  - ii. To assist the positioning of the power switch retaining plate correctly in the right extrusion slide, stand the instrument on its right side. After securing the switch assembly to the retaining plate, ease off the screws and set the switch to Off. Adjust the fore-and-aft position by sliding the whole mechanical assembly until the key cap is flush with the surface of the front panel bezel. Retighten the screws and recheck the key cap alignment.
  - iii. Take care not to trap any wiring when fitting the transformer.
  - iv. Tighten the transformer securing nuts to a torsion of 4Nm using a torque spanner.
  - v. For some early versions, double-sided adhesive tape is required to secure the insulating card on the upper surface of the sub-chassis after refitting a mains transformer.
  - vi. Carry out a final inspection to ensure that the components are correctly fitted. Check that the wiring is set in the correct routing, is not trapped, and the connections are mechanically secure.



## 7.2 Low Voltage Transformer Assembly

*N.B. To fit a low voltage transformer after removal, an M3 torque spanner capable of setting to 3Nm is required.  
For early versions: to refit requires a length of double-sided adhesive tape.*

- Remove rear corner blocks, top and bottom covers: 3.4.1 and 3.4.2.

### • Removal

*(Page 11.1-1, Drawing DA400891 Sh. 2)*

*(Facing page 11.1-4, Drawing DA400893 Sh. 1)*

*(Page 11.1-5, Drawing DA400893 Sh. 4)*

*(Page 11.1-8, Drawing 480750 Sh. 1)*

*(Facing page 11.4-2, Drawing DA400901 Sh. 1)*

- a. Ensure that the instrument is inverted.
  - b. Identify the Low Voltage Transformer in the center of the sub-chassis at the rear of the instrument.
  - c. Identify the green/yellow ground bonding lead from the low voltage transformer to the bonding point between the power input plug and the power fuse, on the sub-chassis.
  - d. Remove the nut from the bonding point and remove the green/yellow lead identified in (c) above. Replace the nut to retain the other bonding leads.
- Turn the instrument to its upright position and disconnect the Molex sockets of the two low voltage transformer cables from PL5 and PL6 on the Digital PCB Assembly. Carefully feed the cables and sockets back through the gap at the end of the sub-chassis, to the same side as the transformer.
- f. Identify the two white 'guard' bonding leads from J103 at the rear of the DC PCB to the two rivetted bonding points on the rear of the guard box and the tongue of its horizontal screen.
  - g. Disconnect the Molex socket of the low voltage transformer cable from J103 on the DC PCB Assembly.
  - h. On the free socket, use a miniature screwdriver to extract the two pins of the leads identified in (f) above from the Molex socket:
 

Press the screwdriver into the pin's slot in the socket body to release the pin latch, while gently pulling the lead and pin out. When refitting, providing it has not been strained, the latch tongue will snap into place when the pin is pushed home.
  - j. Stand the instrument on its right side. Carefully feed the cable and socket back through the cutout in the guard box screen to the same side as the transformer.
  - k. Return the instrument to its inverted position.

- l. Release one end of the perspex cable retainer, by pressing the peg in the center of the plastic split pin and withdrawing the pin. Lift the cable and socket out of the cutout, and re-secure the retainer in position using the split pin.

- m. Remove the two M3 nuts and shakeproof washers which attach the low voltage transformer to the sub-chassis studs.

*Note: In early versions the transformer is secured using long M3 countersunk screws, which are inserted from the upper side of the sub-chassis, and screwed into nuts encapsulated in epoxy resin in the transformer body. Access to the screwheads is more difficult in this case, as the rear panel, the digital assembly, and the insulating card on the upper surface of the sub-chassis must be removed to expose the screwheads. Double-sided adhesive tape is required to secure the card after refitting a low voltage transformer.*

- n. Carefully lift out and remove the low voltage transformer, cables and leads.

### • Fitting

- a. Reverse the dismantling procedure. Pay particular attention to the following points:
  - i. Take care not to trap any wiring when fitting the transformer.
  - ii. Tighten the transformer securing nuts to a torsion of 3Nm using a torque spanner.
  - iii. For some early versions, double-sided adhesive tape is required to secure the insulating card on the upper surface of the sub-chassis after refitting a low voltage transformer.
  - iv. Carry out a final inspection to ensure that the components are correctly fitted. Check that the wiring is set in the correct routing, is not trapped, and the connections are mechanically secure.

## SECTION 4 SERVICING

### 4.1 Routine Servicing

The only routine servicing required under normal conditions is the replacement of the Lithium battery which powers the non-volatile calibration memory.

The calibration requirements after changing the battery are different depending on whether the change was done with power off or with power on. These requirements are summarized in the table below.

#### Summary

After Battery Change			
Servicing and Time Interval	Procedure Section 4	Calibration Required	Calibration Procedure
<b>Change the Internal Battery with Power On</b>			
Not greater than 5 years	4.3	Routine External Cal Internal Source Cal	User's Handbook Sect 8 User's Handbook Sect 8
<b>Change the Internal Battery with Power Off</b>			
Not greater than 5 years	4.3	Special Cal Routine External Cal Internal Source Cal	Sect. 1.4 User's Handbook Sect 8 User's Handbook Sect 8

### 4.2 Adjustment Following Replacement of PCBs

The high accuracy of this instrument demands that its internal environment remains undisturbed after calibration. Thus the manufacturer's calibration certificate is invalidated by removal of the top or bottom cover.

Section 2 gives help in locating the general area of a fault from the error code displayed after a self test. It follows that any investigation which involves access to PCBs will require that recalibration be carried out after the covers are replaced. This principle naturally extends to any PCB replacement.

It is therefore strongly recommended that before proceeding with any investigation, a user should contact the nearest Datron Servicing Center for advice or assistance.



## 4.3 LITHIUM BATTERY - REPLACEMENT

(Datron Part No. 920049)

### FIRST READ THESE NOTES!

- The lithium battery which powers the non-volatile RAM should be changed at or before 5 years from new, and at no greater than 5-year intervals thereafter.
- The following procedures assume that the instrument will remain powered-up during the operations of disconnecting the old battery and connecting the new battery. To ensure memory integrity the soldering iron used must be isolated from line ground (mains earth) by at least 50k $\Omega$ .

External calibration with internal source characterization will be required (*User's Handbook Section 8*) because of the high accuracy of the instrument, whose internal environment will have been disturbed by removing and replacing the top cover. **Removal of either of the covers automatically invalidates the manufacturer's calibration certificate.**

If instrument power does not remain ON during the whole of the procedure 4.3.1 (or 4.3.2 for earlier versions), disconnecting the battery will reset the calibration memory to its nominal state. This will require a Special Calibration to be carried out (*Section 1.4*) as well as the full External Calibration, before the instrument specification can be realized, as calibration data will be corrupted.

It is therefore strongly recommended that the battery be changed with Power ON, immediately prior to a scheduled external calibration.

### 4.3.1 Digital Assembly 400901 - Procedure

- Ensure that power ON is selected.
- Remove the top cover (*Section 3 para. 3.4.1*).
- Remove the battery (refer to *Fig. 4.1*):
  - Attach a heatsink to resistor R104 soldered to the battery positive terminal. Unsolder R104 from the battery terminal.
  - Attach a heatsink to the wire between the negative battery terminal and E101. Unsolder the wire from the battery terminal.
  - Remove the battery from its clip.
- Observing correct polarity, reverse the procedure of step (c) to fit a new battery and solder it in.

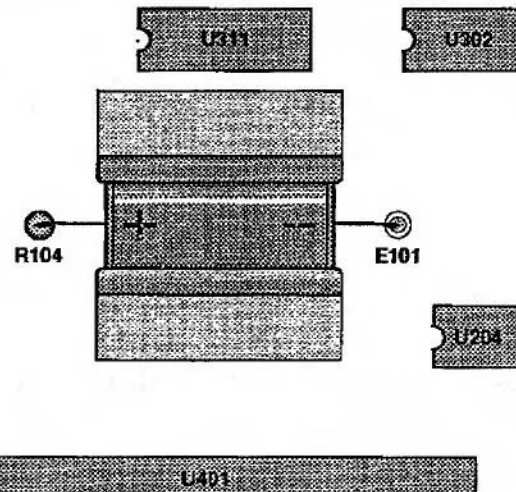

Fig. 4.1 View of Battery from Rear of Instrument

### 4.3.2 Digital Assembly 400740 (earlier version) - Procedure

- a. Ensure that power ON is selected.
- b. Remove the top cover (*Section 3 para. 3.4.1*).
- c. Remove the battery (refer to *Fig. 4.1*):
  - i. Unsolder the wire from the positive battery terminal.
  - ii. Attach a heatsink to R73. Unsolder R73 from the negative battery terminal.
  - iii. Remove the battery from its clip.
- d. Observing correct polarity, reverse the procedure of step (c) to fit a new battery and solder it in.

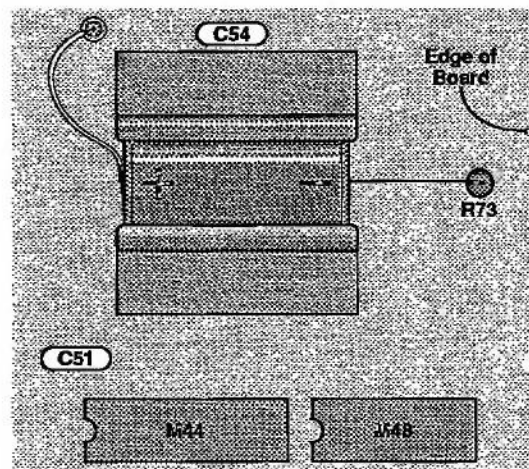

Fig. 4.2 View of Battery from Rear of Instrument

### 4.3.3 Return to Use

- a. Refit the top cover (*Section 3 para. 3.4.1*).
- b. If the instrument power was turned off during the battery-change procedure, carry out the **Special Calibration** detailed in Section 1.4.
- c. Carry out **Full Routine Recalibration with Internal Source Characterization** (*User's Handbook Section 8*).



**SECTION 5  
TECHNICAL DESCRIPTIONS**

## SECTION 5 TECHNICAL DESCRIPTIONS

### 5.1 Principles of Operation

#### 5.1.1 Simplified Block Diagram

Figure 5.1.1.1 illustrates the general functions and signal flow within the 1271.

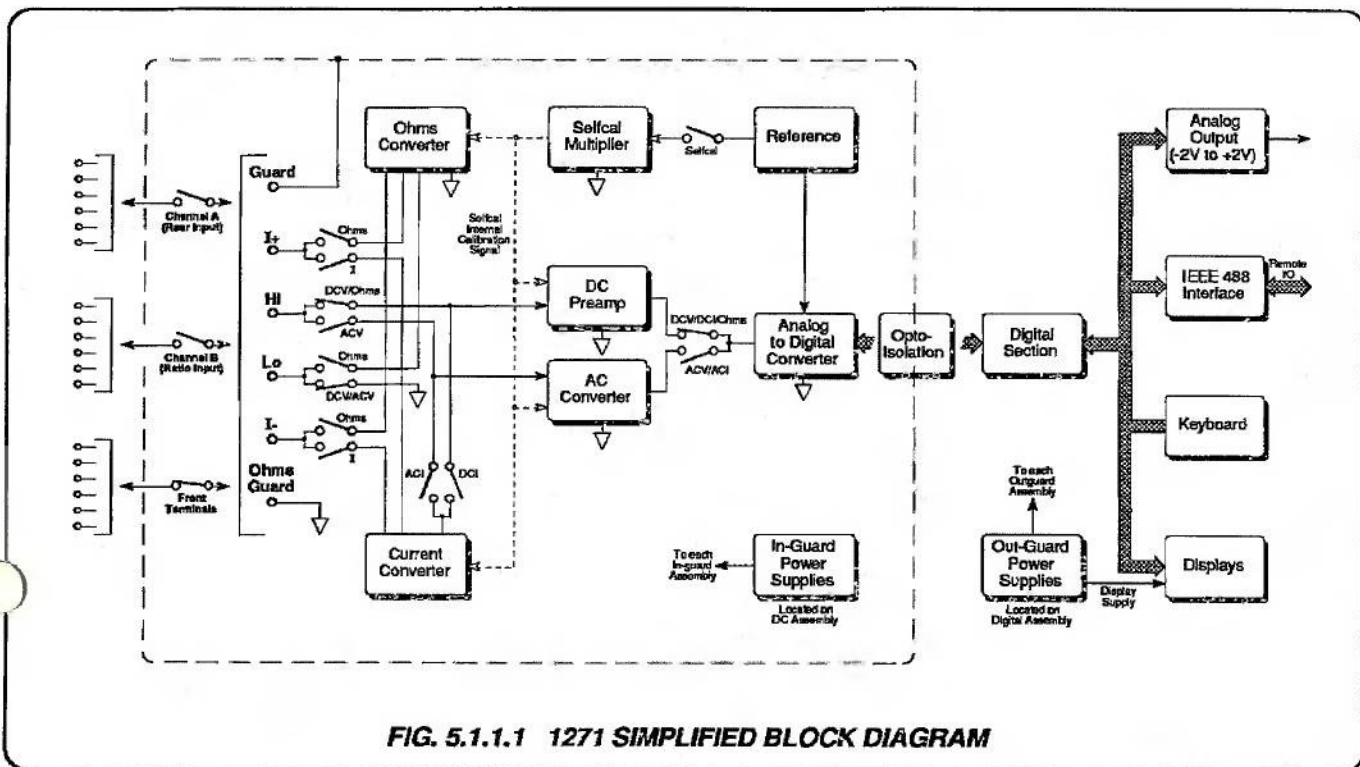

#### 5.1.2 General Description

The Datron 1271 is a premium digital multimeter, designed for the system specialist, with performance optimized for military and aerospace test applications. Its low drift and low temperature coefficients are derived from the inherent qualities of critical accuracy-defining components, which are selected and conditioned before assembly. Conditioning continues after assembly, and further checks are performed to ensure that the instrument as a whole performs well within its specification.

The 1271 employs a method of internal calibration which is designed to enhance performances across the entire range of its functions. After characterizing a low-drift/low-TC internal reference immediately following external calibration, the instrument can be regularly self-calibrated to extend its performance (maintaining approximately 90-day accuracies) up to a year from external calibration.

The instrument is electrically split into two sections divided by ground and guard planes. Measurement circuits are 'in guard'; whereas control circuits and display functions are 'out guard'. Front and rear inputs are routed directly to the measurement circuitry, which includes the multi-slope A-D converter.

Digital computation circuits are out of guard; but digital control of some forty separate in-guard analog parameters, together with transfer of raw digital readings from the A-D converter and any messages from the analog circuits, are effected via a serial interface whose data and control lines are passed in and out of guard through opto-isolators.



#### 5.1.2.1 DC Voltage

The input signal is switched to a DC preamp which amplifies or attenuates the analog signal to a level compatible with the requirements of the Analog to Digital converter. The amplifier is also used to measure resistance and current (Options 20 and 30).

#### 5.1.2.2 Option 10 / Option 12 - AC Voltage

AC voltages are conditioned by the AC preamp, which can be switched to measure AC-only or AC+DC signals. The preamp output is rectified by a precision full-wave rectifier, then passed to an electronic RMS converter which produces a DC level representative of the RMS of the applied signal. This DC level is then digitized by the A-D.

The RMS converter can be switched to provide an AC to DC transfer measurement. This involves sampling and holding the RMS output, and recirculating it twice to obtain a correction for the RMS Converter gain.

#### 5.1.2.3 Option 20 - Resistance

A constant current is passed through the resistor under test. The voltage developed across it due to the current is measured using the DC voltage circuits of the instrument. A wide range of constant currents and DC voltage ranges is employed to optimize performance for differing external conditions.

A 'True Ohms' facility can be programmed which takes two readings: the first is of the resistance plus the DC offset across the resistor with the current flowing; the second is of the DC offset alone with the current off. Subsequent digital calculations subtract the second reading from the first, to eliminate the effects of the DC offset, and the result is presented as the 'True Ohms' measurement.

#### 5.1.2.4 Option 30 - DC and AC Current

*(Option 10 is required for AC Current)*

The unknown current is passed through precision internal shunts and the DC or AC voltages developed across them is measured using the DCV or ACV sections of the instrument. Heavy physical and electronic protection is applied.

#### 5.1.2.5 Option 40 - Ratio

*(Option 40 also provides the third input - Channel B)*

Both Channel A (the standard rear input) and Channel B are independently zeroed and separately guarded. The Ratio option gives DC/DC, AC/DC, AC/AC and  $\Omega/\Omega$  comparison; reference inputs up to 250V RMS can be applied, and outputs can be expressed as a ratio, a difference or a deviation.

#### 5.1.2.6 Analog to Digital Converter

The instrument's multi-slope, multi-ramp A-D converter is a third-generation development of the basic dual-slope integrator and null detector. It has inherent sub-0.1ppm linearity combined with high speed due to signal and reference being applied simultaneously. Flexibility in ramp control permits resolution (and hence speed) to be programmed from 5.5 digits at 1000 readings per second to 8.5 digits in 'Fast' mode at 1 reading per 6 seconds.

Once converted to digital form, readings are transferred out of guard via the serial interface to be managed by the instrument's microprocessor for calibration and display.

#### 5.1.2.7 Internal References

The A-D converter references are derived from specially conditioned and selected DC Reference Modules. These modules are also used as the internal sources of reference for the self-calibration process.

#### 5.1.2.8 Serial Interface

##### Transmission

This is a data transfer system in which a control word is loaded into an ASIC on the digital PCB, and its bits are passed serially through a single opto-isolator into guard. The control word represents an instrument state demanded by the user, in conjunction with firmware programming.

##### Control Functions

In guard, the word is clocked serially through a set of control registers on the DCV, ACV, Ohms and Current PCBs until each bit is located in the specific register appropriate to its control function. At this time, the bits are clocked to the outputs of the registers (or clocked into ULAs to control their functions) and the analog control circuits are switched by the overall bit pattern which, in turn, also represents the demanded instrument analog state.

##### Analog Data Returns

Some in-guard registers are programmed to act as serial transmitters. In these cases the data bits presented at their inputs are clocked into the serial stream, and returned through a single opto-isolator out of guard. The serial data returning to the ASIC are assembled into messages and presented to the processor for decoding and subsequent action.

##### Serial Path Circulation Errors

The control word is transmitted in both true and complement forms; and when it ultimately returns out of guard via another single opto-isolator, circulation errors are checked by comparing it with the original construct.

##### Benefits of Serial Interfacing

Use of the serial interface allows the passage of many data bits across the guard plane, while reducing the number of opto-isolators to eight (some of these are required to control the operation of the interface). If each data bit passed through its own dedicated isolator, then not only would the volume occupied by the isolators set a severe design problem, but also the capacitive and leakage effects in such a large number of isolators would impose prohibitive coupling between in-guard and out-guard areas of the instrument.

#### 5.1.2.9 Digital Circuitry

All major communication, control, keyboard and display processing is performed out of guard, managed by a MC68000 microprocessor. The 68000 is programmed in firmware, using 128k x 16 of EPROM to contain the operating program, look-up tables etc. Workspace consists of 32k x 16 of RAM, with an extra 8k x 8 of RAM permanently powered as a non-volatile memory to store calibration corrections.



## 5.2 PCB Descriptions

*N.B. The A-D section of the DC PCB is described in Sect 5.2.5.*

### 5.2.1 DC PCB

#### 5.2.1.1 Input Switching

*(Circuit Diagram DC400866 sht 1 p11.2-2)*

The front channel input terminals are connected to the DC PCB at J100/101/102 on the left front of the board. Rear input Channels A and B connect to the left rear at J150/151/152 and J160/161/162 respectively.

The leads of each input channel pass through the channel's common mode choke before being subjected to input switching. To enable the instrument to be connected into a system analog bus, each channel is separately isolated by relays when not selected. Separate relays are used throughout for Hi and Lo switching to reduce interaction by leakage and capacitive coupling, latching relays being employed to maintain low thermal EMFs. These aspects are shown on *page 11.2-2*.

Separate Lo switching (Relay K109) is necessary to accommodate the different connection required for operation in Ohms function, when the Lo terminals connect to the OHMS LOW SENSE input of the Low Follower on the Ohms PCB. The  $\Omega$  Guard terminals are loosely coupled (K108/R102) to the main signal common 'MECCA', except in Ohms function, when they are directly connected.

The Guard terminals are always loosely coupled (R101) to MECCA; whereas the internal guard shields and tracks are directly connected to MECCA in Local Guard as shown (K107), or to the Guard terminals in Remote Guard.

The BS line from the output of the DCV Bootstrap Buffer U203 (*p11.2-3*) is connected to the screens of the Hi and I+ leads in the input cable loom to provide a low-impedance guard.

AC\_CAL\_SENSE is used during the AC voltage Selfcal process, and INT\_SIG\_BUS has several uses, mainly to carry internal signals when in Selfcal (*Refer to Section 2: Fault Diagnosis*).

#### 5.2.1.2 Internal Signal Bus

*(Circuit Diagram DC400866 sht2 p11.2-3)*

Quad CMOS gate U202 provides switching mainly for operation in Current measurement and in Selfcal. The INT\_SIG\_BUS line is used to connect various inputs to the DC voltage measurement circuits when they are being employed to measure internal voltages, and not for voltages input from the front terminals. Relay K201 makes this selection.

The internal signal bus comes into operation when the INTERNAL-H signal on U202-1 is at logic-1.

The AC\_CAL\_SENSE line is connected to the bus by the AC\_SENSE-H signal on U202-16 at logic-1.

When it is necessary to load the signal being transmitted via the internal signal bus, the 10M $\Omega$  resistor R220 is connected by the 10M\_LOAD-L signal on U202-8 at logic-0.

Similarly, a hard zero can be connected on the bus by the CAL\_ZERO-L signal on U202-9 at logic-0.

Refer to *Section 2: Fault Diagnosis* for the occasions when these facilities are required.

## Section 5 - Technical Descriptions

### 5.2.1.3 DC Voltage Block Diagram

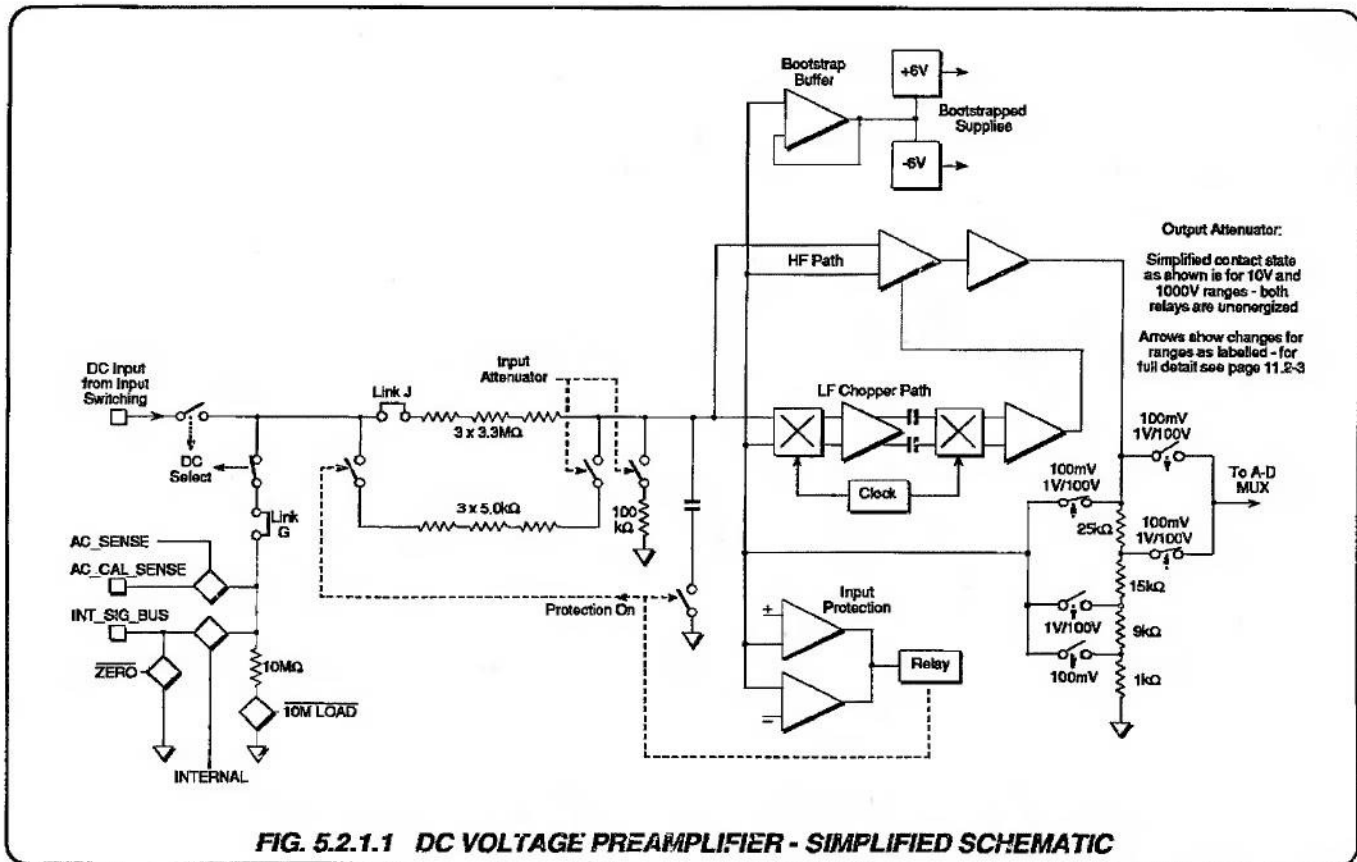

FIG. 5.2.1.1 DC VOLTAGE PREAMPLIFIER - SIMPLIFIED SCHEMATIC

#### 5.2.1.4 DC Voltage Preamp

(Circuit Diagram DC400866 shts 2 & 3 pp11.2-3 and 11.2-4)

The DC Voltage Preamp is based on a chopper circuit (p11.2-4). The required input characteristics are achieved by splitting into LF and HF paths in a multistage design, to ensure good bandwidth and overall gain characteristics. In each path a differential FET input gives low input current characteristics.

This basic design is enhanced by employing a synchronized chopper configuration in the LF path. Noise is also reduced by this method. The signal is chopped by Q304/5/6/7 to modulate the input to differential amplifier Q308/Q309/Q310. The amplifier output signal is AC-coupled to the four U301 gates, which demodulate at the same frequency. After further amplification by U303 the demodulated signal is fed to the output driver stage.

Both paths are combined in a final amplifier stage which provides most of the forward gain with the frequency gain-compensation necessary to give an effective amplifier bandwidth of 600kHz.

#### 5.2.1.5 Bootstrap Buffer

(Circuit Diagram DC400866 sht 2 p11.2-3)

To effect high input impedance, the DC amplifier also drives a Bootstrap buffer U203 (p11.2-3), which ensures that all in-guard power supplies used for the DC amplifier are made to track the input signal level by reference to Bootstrap. The DC amplifier thus sees no change in input signal relative to its supplies, so achieves very high common mode rejection, eliminating any potential common mode non-linearities. In addition, the buffer output sets the potential of PCB tracking which guards the input Hi track, to absorb PCB leakage currents that could otherwise be picked up by input Hi.



### 5.2.1.6 Range Switching

(Circuit Diagram DC400866 sh2 p11.2-3)

Extremely stable resistance units configure the DC amplifier gain to define the DC Voltage ranges. Two attenuators, one at the input and one at the output of the DC Preamp, are switched for range selection.

Refer to page 11.2-10

The output attenuator control signals, at serial interface register U902-18/17, are passed via level-shifter U907 and relay driver U908 to operate relays K204 and K205. The contacts of these relays are shown in the output attenuator on page 11.2-3.

The input attenuator relay K203 is controlled from U902-1 via U907 and U908. K203 contacts are shown in the input attenuator on page 11.2-3.

#### 100mV - 10V Ranges

For these low voltage ranges, the energized relay K203 disconnects R205, so the input attenuator is not effective. K202 contacts and the remainder of K203 contacts are closed to pass the signal through the 15k $\Omega$  input chain in parallel with the 10M $\Omega$  high voltage input chain. Refer to Fig. 5.2.1.1.

In the **10V Range** both relays K204 and K205 are unenergized (the state shown on page 11.2-3). The DC Preamp is connected as a voltage follower, and the output voltage is halved in the output attenuator giving a stage gain of 0.5. Thus input voltages in the range of 0V $\pm$ 20V are reduced to the range 0V $\pm$ 10V for presentation to the A-D.

Relay K204 only is energized for the **1V Range**. The feedback fraction is set at 0.2 by the output attenuator, and the Preamp output is passed without attenuation to the A-D. The stage gain is 5.0, so that input voltages in the range of 0V $\pm$ 2V are amplified to the range 0V $\pm$ 10V at the A-D input.

Relay K205 only is energized for the **100mV Range**. The output attenuator sets the feedback fraction to 0.02, and the Preamp output is passed directly to the A-D. The stage gain is 50.0, so that input voltages in the range of 0V $\pm$ 200mV are amplified to the range 0V $\pm$ 10V for input to the A-D.

#### 100V & 1kV Ranges

For the high voltage ranges the 15k $\Omega$  shunt input chain is disconnected by the de-energized contacts of K203, which also connects R205; so the input attenuator reduces the input voltage by a factor of 100 ahead of the Preamp.

The feedback fraction for the **100V Range** is set at 0.2 by the energized relay K204 in the output attenuator (as for the 1V range) and the Preamp output is passed without attenuation to the A-D. The stage gain is 0.05, so that input voltages in the range of 0V $\pm$ 200V are reduced to the range 0V $\pm$ 10V at the A-D input.

In the **1kV Range** both K204 and K205 are unenergized as in the 10V range, so the DC Preamp is connected as a voltage follower and the output voltage is halved in the output attenuator giving a stage gain of 0.005. Thus input voltages in the range of 0V $\pm$ 1000V are reduced to the range 0V $\pm$ 5V for presentation to the A-D.

### 5.2.1.7 Protection

(Circuit Diagram DC400866 shu 2 p11.2-3)

The instrument can measure up to 1000V. It must therefore be able to withstand continuous application of 1000V on all DCV ranges, to ensure that such a voltage applied inadvertently does not damage internal components.

When the input attenuator is switched in on the 100V or 1kV ranges, 1000V at the input terminals will be reduced to 10V at the input to the DC Preamp. But on low voltage ranges the attenuator is switched out, so static and dynamic methods are used for added protection.

#### Preamp Input Protection

The obvious way to protect the Preamp non-inverting input is by a series resistor chain and two back-to-back zener diodes. The 10M $\Omega$  series element of the input attenuator could be used as the resistor chain, but it would create far too much Johnson noise to be used alone for low voltage ranges. However, as its dissipation is low (100mW for an applied voltage of 1kV) it could form an efficient limiter if it were switched in only when the low voltage ranges are in overload. This is the method chosen for the 1281, using the shunt 15k $\Omega$  chain for normal operation. It will activate the back-to-back zeners for an overload greater than 24V at the Preamp input while preventing problems due to Johnson noise. But it is practicable only in the short-term as it will develop some 60W of heat for an applied voltage of 1kV.

To effect the changeover from the 15k $\Omega$  operating chain to the 10M $\Omega$  limiting chain, the non-inverting input to the Preamp needs to be sensed for overload. As the Bootstrap Buffer is already connected to the inverting input, it provides a suitable low impedance output (B) which follows the input. This is applied to a window comparator U201 which de-energizes K202 only when the overload threshold of 21V is exceeded. Under non-overload conditions K202 is energized, holding the two chains in parallel; but for overload conditions the K202 contacts disconnect the 15k $\Omega$  chain.

#### Protection against High-Voltage HFAC and Transients

As the Bootstrap is designed not to follow high frequencies and transients, it is necessary to couple these into the comparator from the input. This is done by R201 and C201, with zeners D203/4/5/6 clamping the comparator inputs to 0V $\pm$ 22V. The time constant of R217/R218/C203 ensures that when the comparator de-energizes K202 due to a transient, it cannot be re-energized before its contacts have changed over.

#### Preamp Output Protection

As Bootstrap is driven from the feedback point it is vital that the two inputs of the Preamp remain at the same potential. Once the input and Bootstrap are clamped to 24V by the two back-to-back zeners, the Preamp output could lock up due to loss of Bootstrap (and hence collapse of the Preamp's bootstrapped supplies). The Preamp therefore has two clamps: a relative clamp between the output and inverting input to hold these points within 12V of each other, and an absolute limiter as the output approaches the 35V rails.

#### Guarding

The input zeners and output clamps are guarded out by Bootstrap to prevent clamp leakage causing inaccuracies during normal operation.



## **5.2.2 AC PCB - Options 12 and 10**

Section 5 - Technical Descriptions

5.2.2 AC PCB - Options 12 and 10

N.B. References to the Volume 2 of this handbook are aimed at the high accuracy option: Option 12. Where there are differences between Option 12 and the high speed Option 10; these are noted at the appropriate point in the text, and a reference to the Option 10 drawing is also given.

5.2.2.1 AC Voltage - General Principles

The preamplifier buffers and ranges the signal in order to present its output to the RMS to DC converter at the required voltage levels. Once converted to an equivalent DC signal, it is applied to the main A-D converter on the DC PCB.

The description is based on Option 12, so differences for Option 10 are pointed out within the text. Generally, Option 12 is optimized for accuracy, and Option 10 for speed of operation. The AC hardware is different for the two options; Transfer mode is made available in Option 12, but not in Option 10.

5.2.2.2 AC Preamp

(Circuit Diagram 430741 sht1 p115-5)

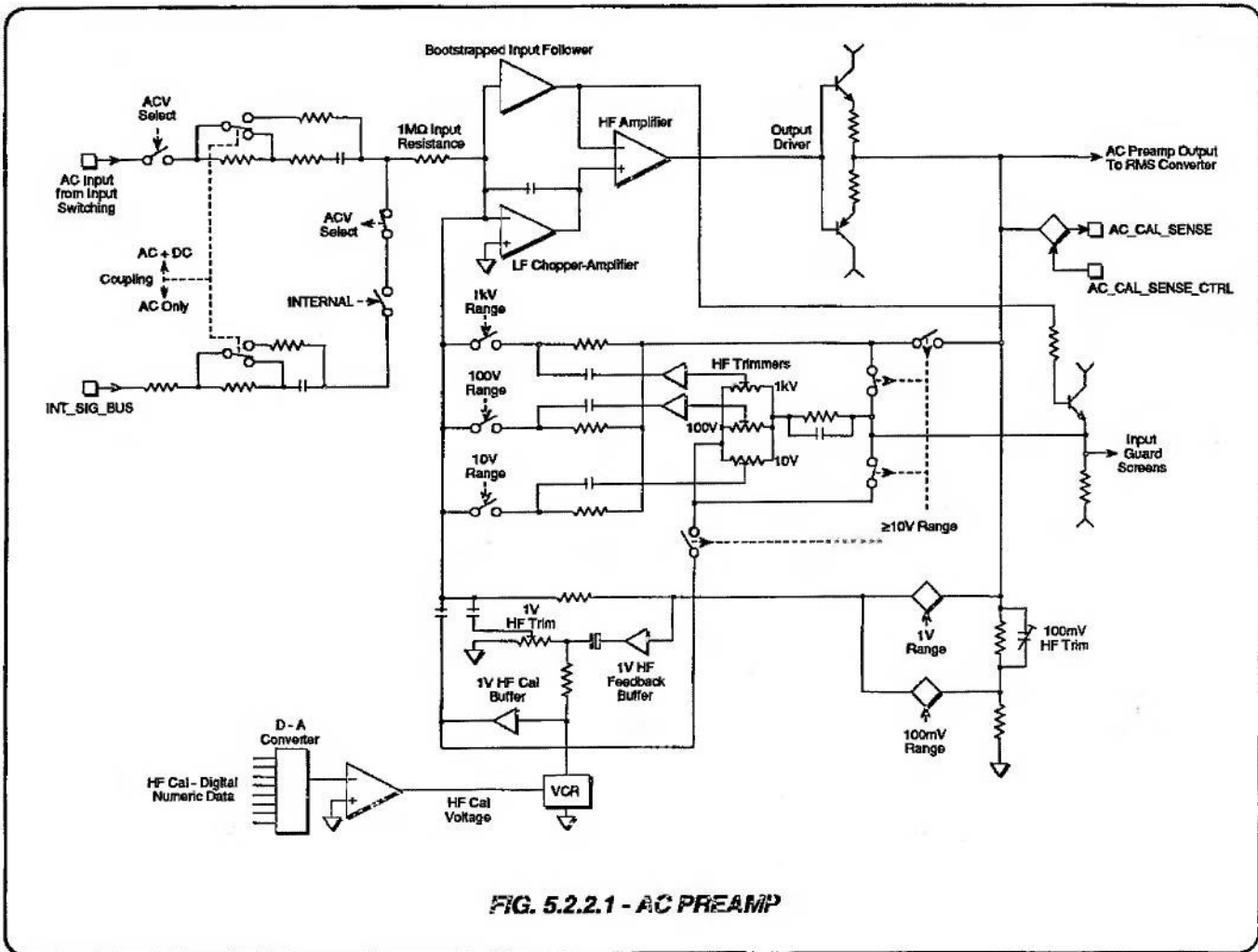

FIG. 5.2.2.1 - AC PREAMP

The requirement for the inverting preamp is to provide good flatness from DC to 1MHz, while the offset voltage at its output must be minimized to ensure good DC-coupled performance.

This complex design uses several gain elements in conjunction with each other.



### Inputs

For normal ACV operation, the input **Hi** is fed from the DC PCB at PL32-4. Relay RL101 connects **Hi** to an AC/AC+DC changeover network, and ensures that the INT\_SIG\_BUS is disconnected from the input to the Preamp. RL102 performs the changeover by shunting the AC coupling capacitor C101 when AC+DC is selected.

During AC Current operation or Selfcal, RL101 disconnects **Hi**, and connects the INT\_SIG\_BUS to the Preamp input instead. A second AC/AC+DC changeover network is switched by RL102 for use in these modes.

### Low Frequencies

As the Preamp is an inverting amplifier, the closed loop gain at low frequencies is set by input and feedback resistance. The input resistance of  $1M\Omega$  is formed by four  $250k\Omega$  resistors in a series chain, spreading the input voltage and power on the 1kV range, and permitting simple compensation at high frequencies. This input chain is present on all AC Voltage ranges.

Feedback resistance is switched to select voltage ranges. The basic range is the 1V range with an overall gain of 1, using two  $500k\Omega$  resistors in series as feedback. FET Q116 is switched on for all ranges except the 100mV range. For the 100mV range, the feedback is divided in the ratio 1:10 by R186/R187 by switched Q116 off and Q117 on, still using the 1V range resistors to feed back to the input.

For the three higher voltage ranges, relay RL107 connects the preamp output to the three feedback resistors. For the 10V range, feedback resistor R168 is effectively connected in parallel with the 1V range feedback resistance R148/R169 by relay RL106. For the 100V range, feedback resistor R167 is added in parallel with the combined 10V range feedback resistance by relay RL105; and for the 1kV range, RL104 adds R191 in parallel with the combined 100V feedback resistance. As the 1kV range has both a full range and full scale of 1kV, it is not necessary to reduce the gain to .0001. Using the larger value of  $2.4k\Omega$  for R191 gives an overall gain of approx .0019, reducing the value of the required compensation capacitor. The 1kV range thus behaves internally as though it were a 500V range with 100% overrange.

### High Frequencies

The feedback resistors are shunted by compensating capacitors which determine the closed loop gain at high frequencies, swamping the stray capacitance around the preamp. Trim resistors allow the compensation to be pre-set once the AC PCB is fitted into its guarded environment in the instrument. Voltage followers M103 buffer the HF feedback drive on the 100V and 1kV ranges, which have lower-value feedback resistors and hence larger compensation capacitors.

FET Q115 and transistor Q120 form an HF feedback buffer for the 1V and 100mV ranges. After DC isolation by electrolytic C140, the buffered output is trimmed by pot R178 and fed back via C148. The buffered output also energizes the HF autocalibration voltage divider formed by R174 and VCR FET Q119.

### LF Autocalibration

The low frequency gain is calibrated by correcting the digital output from the A-D while inputting a known signal. The corrections are stored digitally in non-volatile RAM, and are subsequently reapplied by digital computation during normal operation.

### HF Autocalibration

To calibrate the HF gain, separate digital correction factors are derived from measurements of known HF inputs, and reapplied as a DC voltages to M104 via a ladder network D-A converter R189. The HF correction factor for the currently-selected range is passed from the microprocessor to the AC PCB via the serial interface, latched into M402 (page 11.5-8), and delivered direct to the D-A R189 (page 11.5-5).

The output of M104 controls FET Q119, which acts as a voltage-controlled resistor. The buffered and isolated preamp output voltage is developed across R174 and Q119, and the voltage across Q119 is applied via Q118 and C147 to the preamp input. Thus the correction factor embodied in the bit pattern on the input to the D-A R189 controls the amplitude of the HF feedback and hence the HF gain of the preamp.

FET Q114 is included to compensate for any non-linearity in FET Q119, the two FETs forming a matched pair, with common-value bias resistors. Thus the source-drain currents in both FETs are identical, the amplitude of the AC voltage across Q119 is linearly proportional to the resistive current from the D-A to M104 input, and hence is also proportional to the quantitative value of the bit pattern delivered to R189.

### Selfcal

For self-calibration and self-testing purposes, the internal DC Source can be characterized during external calibration. During Selfcal, the appropriate value of DC reference is applied via the INT\_SIG\_BUS line, and the AC+DC gain of the preamp is measured by the DC voltage system via the AC\_CAL\_SENSE line. Further measurements are taken from the output of the RMS section directly via the A-D.



Section 5 - Technical Descriptions

5.2.2.3 Electronic RMS

The principles behind the RMS conversion technique are shown in Fig. 5.2.2.2.

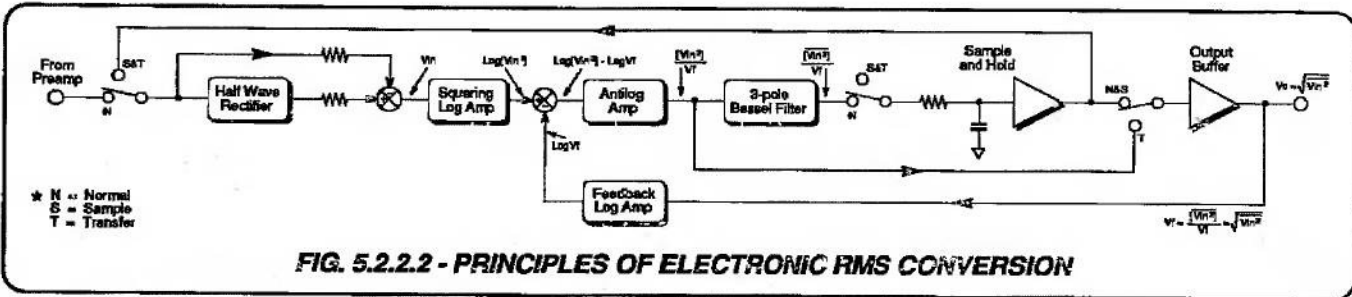

**Rectifying the Preamp Output**

With the instrument set to its 'Normal' mode, and for the first of three readings when using the "Transfer" facility; the output signal from the Preamp is applied to the Precision Rectifier. This is required to provide full-wave rectification with identical AC and DC gain for both positive and negative excursions, and to ensure that the crest factor of sinusoidal and non-sinusoidal signals is not altered in the process.

To achieve this, positive excursions are removed by half-wave rectification, the negative excursions being inverted by the rectifier. The amplitude of the rectifier output can be adjusted using the DC-to-DC Turnover control, which incrementally changes the rectifier gain around a factor of 2. The rectifier output is then summed with the Preamp output. The result, shown in Fig. 5.2.2.3 for a sine waveform, is a full-wave signal which can be set to give identical gain on both positive and negative excursions. This is input to the squaring log amp (as  $V_{in}$ ).

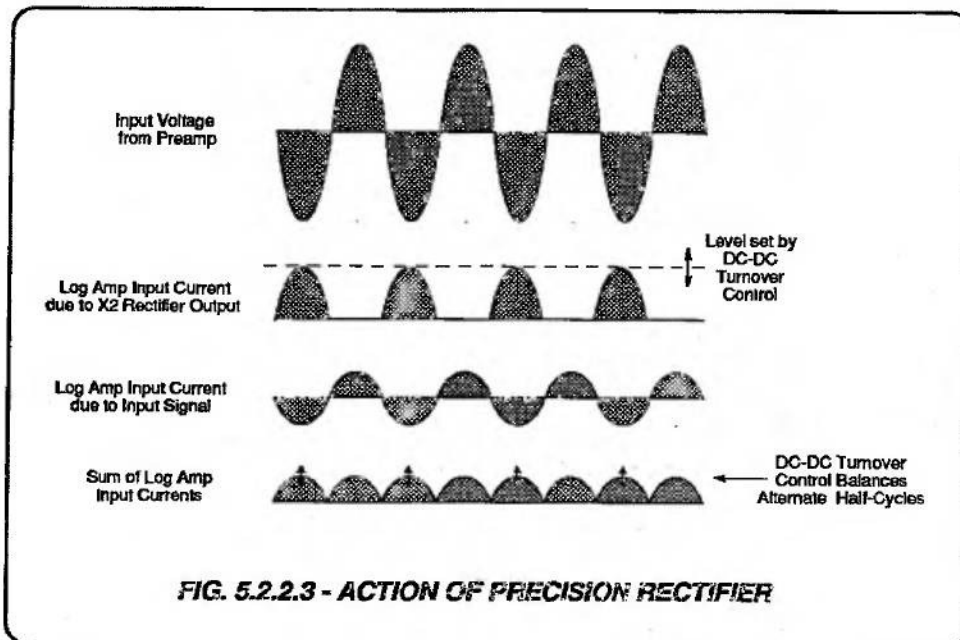



**Squaring the Rectified Input**

The Log Amp squares instantaneous values of  $V_{in}$ , by converting them into logarithmic values and then multiplying by two. Its instantaneous log output voltage is therefore proportional to  $2\log V_{in}$ , which can be expressed as  $\log[V_{in}]^2$ .

**Dividing by the Converter Output**

The Log Amp output voltage is applied to a summing circuit, together with a feedback DC voltage whose value is proportional to  $-\log V_f$  ( $V_f$  is a DC voltage - the mean output voltage from the converter, returned via the feedback Log Amp). The current from the summing junction is proportional to  $\log[V_{in}]^2 - \log V_f$ , which can be rewritten as  $\log[V_{in}^2/V_f]$ . It drives an exponential stage whose output voltage is proportional to the antilog of its input current, in this case proportional to  $V_{in}^2/V_f$ .

**Taking the Mean**

The output from the exponential stage is smoothed by a 3-pole Bessel filter, resulting in a DC voltage for a settled periodic signal. This is therefore proportional to the mean of  $[V_{in}^2/V_f]$ .

As  $V_f$  is DC and therefore equal to its mean, this is the same as:  
 $[\text{mean } V_{in}^2]/V_f$ .

**Closing the Square-Root Loop**

The feedback loop is closed by feeding  $V_f$  back into the computation, as mentioned earlier, to ensure that the DC output signal  $V_f = [\text{mean } V_{in}^2]/V_f$ . From this it can be seen that  $V_f^2 = [\text{mean } V_{in}^2]$ , and  $V_f = \sqrt{[\text{mean } V_{in}^2]}$ , which is the normalized root-mean-square value of  $V_{in}$ .

**Normal Mode Settling**

The Bessel filter is chosen for its optimum settling time, and offers selectable configurations to permit operation down to 1Hz. A sample and hold circuit with isolating buffer (for use in 'Transfer' mode - see below) provides further filtering at higher frequencies, after which the smoothed signal is taken to an amplifying buffer which drives the instrument's analog to digital converter.

**Simplified Circuitry**

A simplified version of the RMS analog computing circuitry is given at Fig. 5.2.2.4. Note that the input and feedback components responsible for the logging, squaring and antilogging are contained within the 'RMS Chip'.

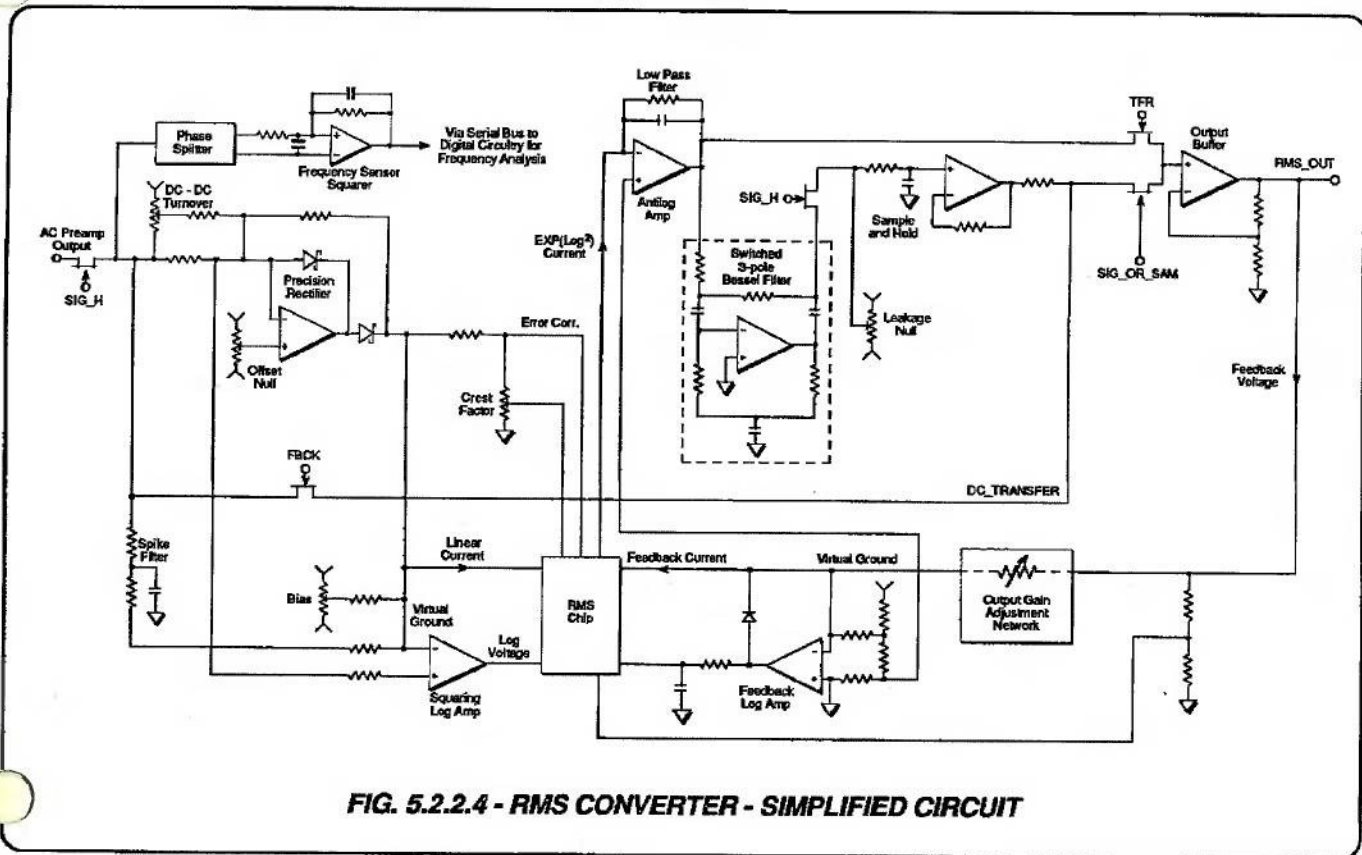

FIG. 5.2.2.4 - RMS CONVERTER - SIMPLIFIED CIRCUIT

5.2.2.4 AC-DC Transfer Mode (Not Option 10)

So far, the described circuit is a straightforward electronic RMS measuring system. As an alternative, Option 12 also employs a refinement on the basic technique, using an AC-DC transfer mechanism to improve linearity by measuring and correcting the gain of the RMS Converter.

This requires three readings, shown in Fig. 5.2.2.5 as 'Normal', 'Sample' and 'Transfer', equivalent to the switching positions shown on Fig. 5.2.2.2.

Refer to Fig. 5.2.2.5, and to Option 12 *Circuit Diagrams 430741 Sheets 2 and 3; pages 11.5-6 and 11.5-7.*

Note that on the equivalent Option 10 *Circuit Diagrams DC400870 sheets 2 and 3; pages 11.5-2 and 11.5-3*, the transfer components are not present.

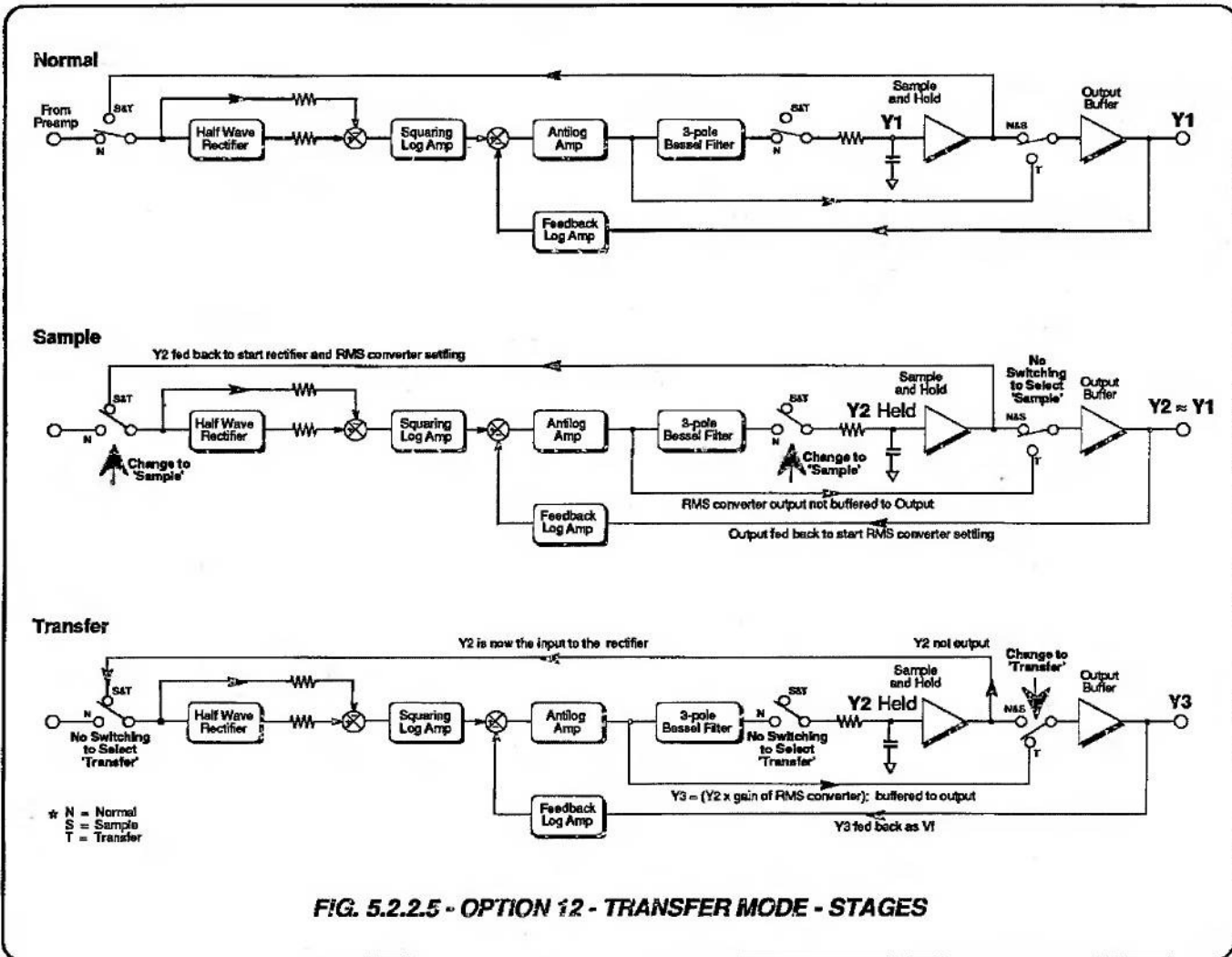



**First Reading - Normal**

With the circuit connected as in Normal Mode, a reading **Y1** is taken and delivered via the A-D to the digital circuitry. This is memorized by the microprocessor. Meanwhile the Sample and Hold capacitor has charged up to **Y1**.

**Second Reading - Sample**

The input to the Sample and Hold circuit is removed to store the capacitor voltage. A second 'Sample' reading **Y2** is taken via the A-D. This reading is the instantaneous value at the time when the input signal was removed. It is approximately equal to **Y1**.

**Third Reading - Transfer**

The Sampled voltage **Y2** is passed through the RMS Converter, and the output from the Antilog Amp is measured as **Y3**.

There are now three digitally stored readings:

- Y1:** is the fully-converted uncorrected reading of the input to the instrument;
- Y2:** is the voltage stored on the sample-and-hold capacitor;
- Y3:** is the result of recirculating the sample-and-hold voltage through the RMS Converter (the signal does not require filtering as it is already DC).

The second reading **Y2** is necessary only because the input could have been broken at the peak or trough of the small amount of ripple which could be present. Both **Y2** and **Y3** are now taken with respect to the same DC voltage, so the ratio **Y3/Y2** is a measure of the DC gain of the RMS Converter. To correct for the RMS Converter gain, the inverse ratio **Y2/Y3** can now be applied to the raw signal **Y1**.

The microprocessor therefore computes the corrected reading of the input to the instrument by:

$$\text{Corrected Reading} = Y1 \times (Y2 / Y3)$$

Because the second and third readings use only the DC sample-and-hold voltage as input, the correction is equivalent to an AC to DC conversion. Because the signal level of the DC readings is at the same level as the signal to be corrected, any gain or linearity errors in the RMS conversion are virtually eliminated.

**5.2.2.5 Frequency Sensing and Display**

(Fig. 5.2.2.4 and Circuit Diagrams 430741 sheets 2 & 4, Pages 11.5-6 & 11.5-8)

**Frequency Sensing**

The Preamp output is AC-coupled to differential buffer Q201 (page 11.5-6). This provides split-phase versions of the signal to drive M409 comparator (page 11.5-8), which squares the fundamental while suppressing harmonics. The resulting output from the comparator is passed to the FLL ULA M412.

**Counting and Encoding**

The frequency is counted by the ULA within a long or short gate initiated by the CI2\_R signal. The output from the 4MHz crystal clock X401 is also counted, within the selected gate, as frequency reference. The ULA computes the frequency by comparison between the two counts, and constructs a data word representing the signal frequency. This word is placed into the ULA serial interface register and the microprocessor is alerted by the RTX\_R signal that a message is ready.

**Frequency Display**

The processor then performs the necessary serial transfer to obtain the message for decoding and display. The frequency can be presented on the menu display at the same time as its RMS value is being shown on the main display, by using **Freq** in the **MONITOR** menu when **ACV** is selected. If the instrument is in **ACV SPOT FREQUENCY** mode there is also an indication when a **Spot** frequency is active.

**5.2.2.6 Spot Frequency Calibration**

Each ACV range can be spot calibrated at up to six independent user-defined frequencies, reducing flatness errors within  $\pm 10\%$  of the spot frequency. The process is performed entirely in software, no alteration to the hardware configuration being involved.

**5.2.2.7 AC Current Measurement**

The input AC current to be measured is passed through one of the shunts on the Current PCB, and the resulting shunt voltage is transferred to the AC PCB to be measured on the 100mV range. The voltage is developed between INT\_SIG\_BUS and 0V(10) on the Current PCB, and appears between INT\_SIG\_BUS and 0V(7) on the AC PCB. Both commons are joined at MECCA on the DC PCB.



### 5.2.3 Resistance - Option 20

This function is achieved using a set of constant current sources in conjunction with the DCV measurement capability.

#### 5.2.3.1 Normal Ohms - Functional Block Diagram

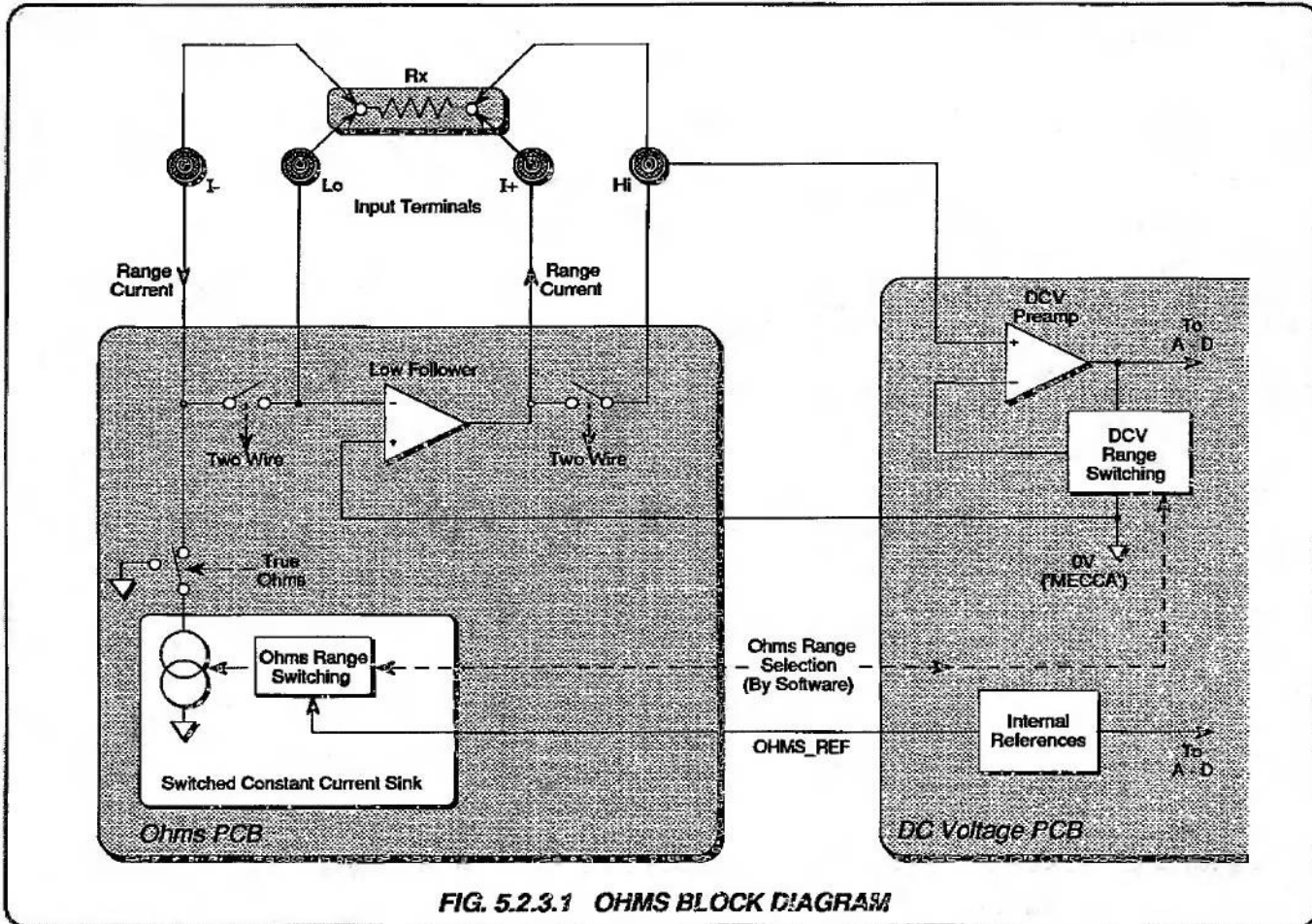

FIG. 5.2.3.1 OHMS BLOCK DIAGRAM

#### 5.2.3.2 Switched Constant Current Sink

(Circuit Diagram 430742 Sheet 2 Page 11.6-2)

##### Reference

The accuracy of all the values of current available for resistance measurement is derived from the Internal Reference on the DC PCB. The reference voltage is one of the outputs of the Reference Buffer U406 (page 11.2-5), which is developed between **OHMS\_REF** and 0V(12). On the Ohms PCB, this is isolated by a 'Flying Capacitor' pump circuit switched by astable multivibrator M204. M204 is enabled only when resistance measurements are to be taken, or when an Ohms constant current is to be used as input to the current-to-voltage converter on the Current PCB in Selfcal and Self Test. At times when the pump circuit is disabled, the zener D202 is used as reference for the voltage mirror.

The astable M204 is enabled by the **'OSC'** signal, which passes from the processor to the Ohms PCB via the serial interface, latched into M301 (page 11.6-3). It is then decoded, and delivered to M204-4/9 (page 11.6-2).

##### Sink Circuit

Voltage mirror M203/Q208 maintains a constant voltage across a series resistor chain R204, R214, R219 and R217/R218 (parallel to spread the load for 10mA selection).

##### Constant Current Switching

By shunting and picking off currents, any one of the range of constant currents can be drawn through the resistor under test. Each Resistance Mode and Range combination is assigned its own value of current, the FET/Relay activation pattern being controlled in firmware. Switching arrangements for the currents are shown in simplified form on Fig. 5.2.3.2. Table 5.2.3.1 relates the constant current value to the Mode and Ohms range selected by the user.



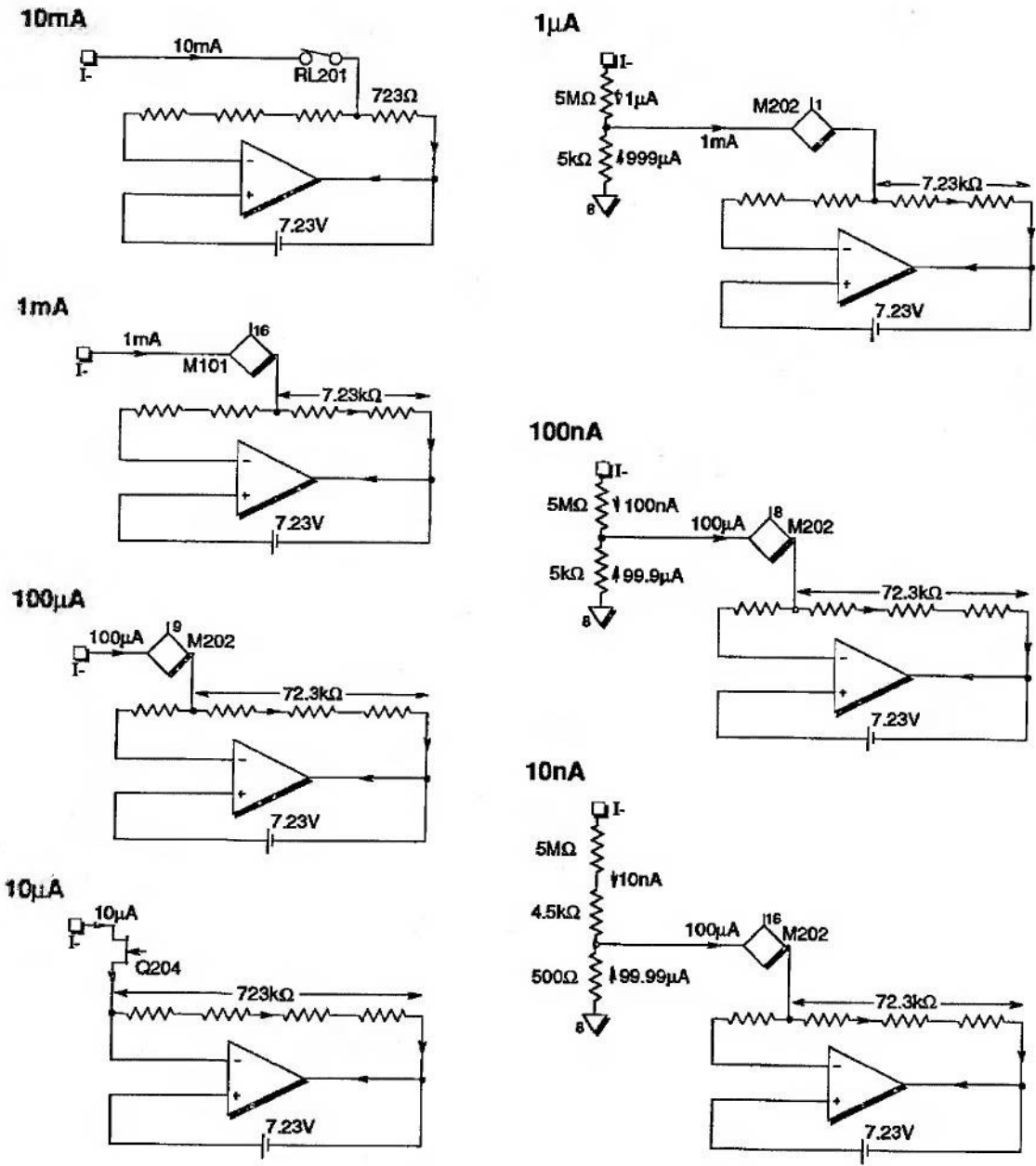

FIG. 5.2.3.2 OHMS CURRENT SWITCHING

### 5.2.3.3 Low Current Ohms

Where low compliance or low open circuit voltages across the DMM's terminals are needed, a special low current mode (LoI) can be selected. Applications where this can be useful include in-circuit measurement of components in parallel with diode junctions, or the measurement of temperature using Platinum Resistance Thermometers, where the self-heating effects of the current passing through the resistive element are important.

The 100mV DC Voltage range is used for all low current Ohms measurements

### 5.2.3.4 True Ohms

In addition, for those applications where external thermal emfs present measurement problems, a mode is provided where a zero reference reading is automatically taken with the measurement current turned off (Tru  $\Omega$ ). This zero measurement is subsequently subtracted from that made with the current flowing, to give a resultant value where the effect of any thermal emfs have been eliminated.

### 5.2.3.5 Low Follower and Voltage Detection

External errors produced by specific connections can be reduced using four-wire sensing and Ohms guarding techniques. Four-wire sensed measurement can be made with up to 100 $\Omega$  in any lead with no degradation in accuracy. Furthermore, errors caused in external leakage paths can be eliminated using an Ohms Guard terminal which may also be used for in-circuit measurement of components in parallel with other resistive elements.

The aim of the Low Follower is to separate the current path from the voltage detection circuit, so that in 4-wire connection the current flows through the resistor under test, and the voltage across it is detected at the resistor itself with no other common wiring.

#### Current Path (Fig 5.2.3.1)

(Circuit Diagram 430742 Sheet 1 Page 11.6-1)

The resistor under test  $R_x$  is connected between I+ and I-. The energizing current is drawn from I- by the constant current sink, and sourced through the power output stage of the Low Follower into I+. The value of the constant current is switched at the sink as described above.

Lo is connected to the Low Follower inverting input, and because this places  $R_x$  as the feedback resistor, Lo is forced to the same potential as Common-8 at the Low-Follower non-inverting input. Virtually no current flows in the low line, as the bias current required by the Low Follower is very low.

When measuring in 4-wire, I- and Lo are connected together only at  $R_x$ , so current in the I- line does not pass through any part of the Lo line, and the resistor Lo terminal is held at the potential of Common-8. With 2-wire selected, the constant current does pass through part of the Lo line, and an IR drop is generated across the ends of the path. At the Hi end of the resistor, the source current is drawn through the I+ line, and in 4-wire it does not pass through any part of the Hi line.

#### Voltage Measurement across $R_x$

The voltage due to the constant current in  $R_x$  alone is presented between Hi and Lo with no other IR drop. The Lo end is held at Common-8, which is the same as the 'MECCA' on the DC PCB. The DC Preamp presents an extremely high impedance to Hi, so the voltage measured by the DC Voltage circuitry is that across the resistor  $R_x$  alone.

When a particular Resistance range is selected, its energizing current value is determined by firmware, the results of the measurements being modified by calibration constants. The setup must have optimum constant current and optimum DC Voltage measurement range for low noise and stability. This choice is predetermined and set in the program; the range of setup conditions are shown in Table 5.2.3.1.



**Low Follower Amplifiers**

The Low Follower is a compound amplifier, with M103 and Q108 DC-stabilizing Q104 and M102. The two paths are recombined by M104 summing amplifier.

**Alternate Current Sourcing**

For thermal reasons, Q110 is supplied from +35V for low current values, and +5V for high currents. The changeover occurs via diode D106.

**Clamping**

Clamping is used to limit the voltage drive to Q110, at values dependent on the DCV range used to measure the voltage across Rx. For the 10V range, the CLAMP signal (Q115 gate) is at +5V, and the voltage at the junction of R137/138 limits at +25V. With the 100mV or 1V range in use, CLAMP changes to 0V and the limit is reduced to +5V. The CLAMP signal is set by the processor via the serial data link, the programmed level appearing at DIO7, pin 12 of M301 (page 11.6-3).

**Ohms Low Sense**

The input channel Lo terminal cannot not taken directly to 'MECCA' common when resistance is being measured; instead it is switched to the  $\Omega$  LOW SENSE line into the Ohms PCB. It is maintained at high impedance while being referred to 0V(8) by the action of the Low Follower.

Low switching is performed by relay K109 on the DC PCB (Circuit Diagram DC400866 page 11.2.2).

**2-Wire/4-Wire Switching**

The input channel Hi is fed directly to the DC PCB for the voltage measurement across the resistor Rx, and for this purpose does not need to appear on the Ohms PCB. However, the 2-wire/4-wire switching is performed by Ohms relay RL101 between Hi and I+, so Hi is brought on to the Ohms PCB to be switched. On the Lo side, RL101 connects  $\Omega$  LOW SENSE to I- in 2-wire. The 2-wire links are protected by thermistors.

**True Ohms Switching**

The first of the pair of True Ohms readings is the same as normal, with relay RL104 energized at contact 1. The second is taken with no current drawn through Rx via I-, as RL104 is unenergized at contact 14. Thus the constant current sink is sourced directly from Common-2.

**Selfcal and Selftest**

During self-calibration the Ohms ranges are calibrated with reference to two standard resistors fitted on the Ohms PCB - R105 and R106. These are switched out by RL102 being energized during normal operation, but for Selfcal and Selftest the I+ input is disconnected, and the Ohms circuit measures the values of the two resistors as they are switched in by the contacts of the de-energized RL102. For a low standard resistance R106 (1.0k $\Omega$ ) is selected on its own, and for high resistance R105 and R106 are connected in series (101k $\Omega$ ); the switching being performed by RL105. The software models for Selfcal and Selftest are given in Section 2.

**Filter**

C108 and R126 provide HF compensation for the whole Low Follower. When Filter is selected, the F signal at +5V introduces C107 in parallel with C108 to reduce the frequency response of the follower. In this state, Q107 is turned off to turn Q106 on. The F signal originates on the DC PCB as FILTER (page 11.2-10), its level having been set at pin 15 of the register U902, by the processor via the serial data interface. So both the DC Voltage and Ohms filters are switched in and out simultaneously.

**5.2.3.6 3-Bit Word Transfer and Decoding**

A 3-bit word which represents the current switching pattern is passed from the microprocessor to the Ohms PCB via the serial interface, latched into M301 (page 11.6-3), and DIO 2/3/4 is delivered to M304-1/2/3 for decoding. Signal DIO4 is also added to the decode, and the resulting decoded lines are used to generate the FET/Relay switching pattern.

When a particular Mode/Range combination is selected in Resistance Function, the Processor translates the selection into the corresponding 3-bit pattern to activate the current. It also sets the appropriate DC Voltage range. Table 5.2.3.1 relates the constant current value and DC Voltage range used, to the Mode and Ohms range selected by the user.

**Table 5.2.3.1 Ohms Range, Mode and Current; with DC Voltage Range Employed**

Ohms Range	Ohms Current						
	10nA	100nA	1µA	10µA	100µA	1mA	10mA
10Ω							TruΩ 100mV
100Ω						Lol 100mV	Normal 1V TruΩ 1V
1kΩ					Lol 100mV	Normal 1V TruΩ 1V	-
10kΩ				Lol 100mV	Normal 1V TruΩ 1V	-	
100kΩ			Lol 100mV	-	Normal 10V TruΩ 10V		
1MΩ		Lol 100mV	-	Normal 10V			
10MΩ	Lol 100mV	-	Normal 10V				
100MΩ	-	HiΩ 10V					
1GΩ	HiΩ 10V						



## 5.2.4 DC and AC Current - Option 30

The DC Current function is achieved using a set of precision shunts in conjunction with the DCV measurement capability. The AC Current function uses the same set of shunts in conjunction with the ACV measurement capability. Option 30 requires Option 20 also to be fitted, as it is self-tested and self-calibrated using currents provided by the Ohms circuitry.

### 5.2.4.1 Functional Block Diagram

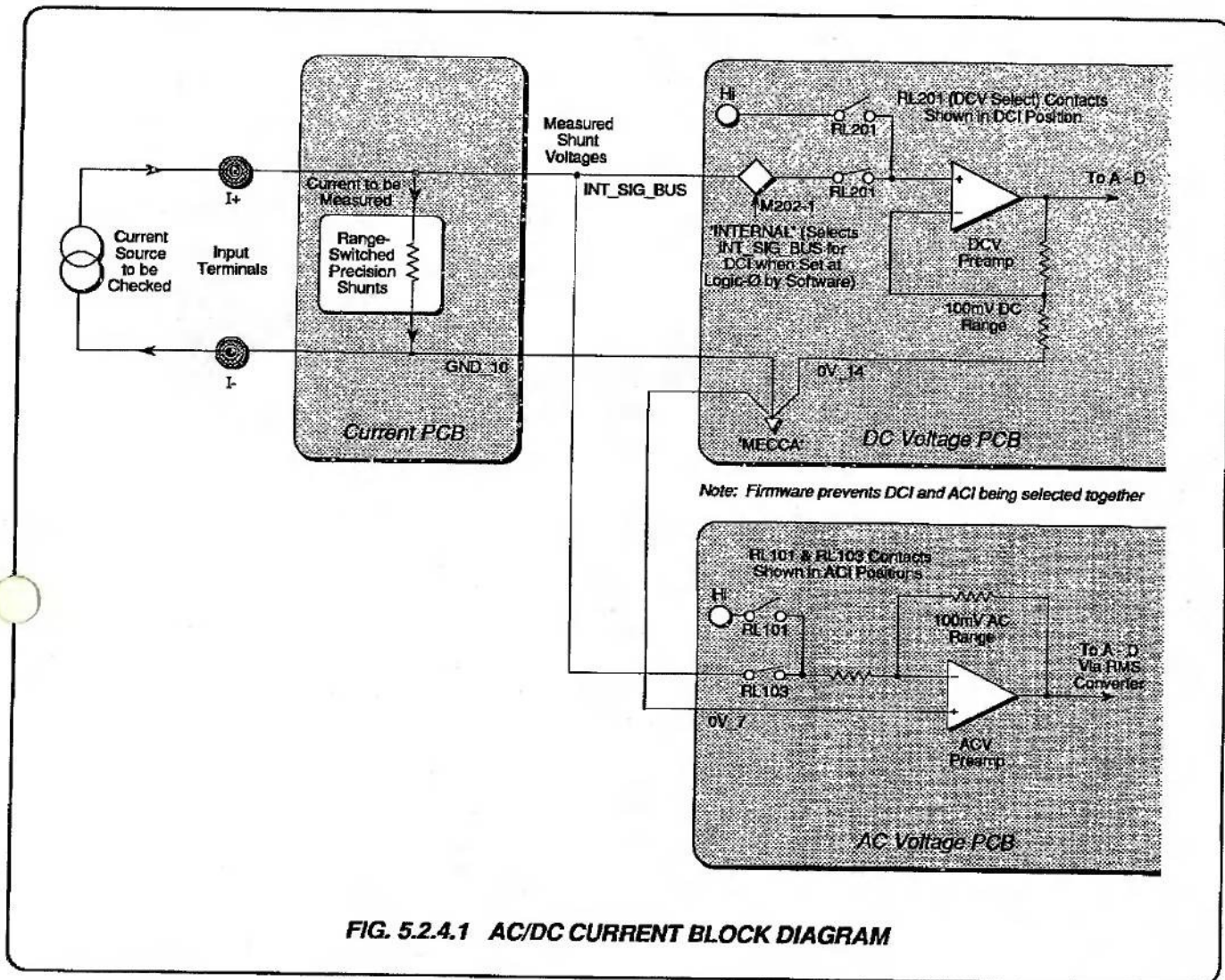

### 5.2.4.2 Switched Current Shunts

#### General

For Current measurement, five precision shunts are switched internally to correspond with selection of the five ranges. The unknown current passes through one or more of these shunts, and the resulting voltage is measured using the 100mV DC or AC range circuitry. The shunts and the source of the current are protected both electronically and by a 1.6A fuse, accessible on the rear panel.

#### Input Current Routing

The current from the selected input channel enters the Current PCB at PL52-1 (Hi), passes through the fuse and selected shunt(s), and exits by PL50-6 (Lo).

On the Current PCB the current path is interrupted by three open contacts of RL100 when the Current Function is not selected. The contacts are closed in Current Function.



**Shunt/Range Correspondence**

Table 5.2.4.1 relates the range switching to the selected range and range shunts utilized.

**Table 5.2.4.1 Current Range Switching**

Range	Shunts				
	R111 900Ω	R112 90Ω	R113 9Ω	R114 1Ω	R115 0.1Ω
100μA	M101-9 / Q101				
1mA	M101-16 / Q102/103				
10mA	RL102				
100mA	RL103				
1A	RL104				

**5.2.4.3 Shunt Voltage Measurement**

**Sensing**

For each range, the voltage to be measured across the range shunt(s) appears between common **GND\_10** at PL51-1 and **INT\_SIG\_BUS** at PL51-2. **GND\_10** is connected as **0V\_10** directly to MECCA via J141-1 on the DC PCB (page 11.2-2).

For all the ranges up to 100mA, the unenergized relay RL104 contacts 2/3 (closed) and 4/5 (open) connect **GND\_10** to R114, switching out the volts drop across the 1A shunt R115 (although the input current for each range passes through R115 on its way to I-). On the 1A range, RL104 is energized to connect **GND\_10** to R115 instead of R114.

**Measurement (DC Current)**

The DC voltage circuitry is referred to MECCA (page 11.2-2). For the DC Current function, the input to the DC Voltage preamp is connected to **INT\_SIG\_BUS** instead of the external inputs. The **INT\_SIG\_BUS** line is selected on the DC PCB by U202-1 and the unenergized relay K201 (page 11.2-3). The DC preamp passes the conditioned DC signal to the A-D.

**Measurement (AC Current)**

The AC voltage circuitry is referred to MECCA via common **0V\_7** (page 11.2-2). For the AC Current function, the input to the AC Voltage preamp is connected to **INT\_SIG\_BUS** instead of the external inputs. The **INT\_SIG\_BUS** line is selected on the AC PCB by RL103-5/4 and the unenergized relay RL101-2/3/9/8 (page 11.5-1). The AC circuitry converts the AC voltage to a DC (RMS) voltage, which is passed to the A-D.

**5.2.4.4 Protection**

**Fuse**

The 1.6A Current fuse is located for access on the rear panel, and connected in series with the I+ line via PL54-1/2. The fuse is tested during Selftest (see below), and although not specifically tested in Selfcal, will cause Selfcal to fail if it is not intact.

**Diodes**

Four diodes D103-D106 protect the shunts when an attempt is made to measure a current which is too large for the range in use, limiting the voltage across the shunt(s) and blowing the fuse if the excess current is large enough. For normal operation, any leakage current in the diodes is guarded out by the bootstrap M102.

**Bootstrap**

M102 buffers the voltage at the high end of the shunt chain as **0V\_B**, which in Current function drives the center connection of the four protection diodes. Thus there is no voltage across the top two diodes, so all the input current passes through the shunt(s). The bootstrap forces the shunt voltage across the bottom two diodes, so leakage current is diverted to **GND\_10** and back into the power supply for buffer M102.

In Selftest and Selfcal, the input test current is sourced, via the I+ line, from the Low Follower output on the Ohms PCB. It returns to (and is controlled by) the constant current sink on the Ohms PCB, via the I- line. In this case RL101 is energized, forcing **0V\_2** at the diode junction. This maintains zero voltage across the bottom pair of diodes, and diverts leakage current from the top two diodes into **0V\_2**, instead of into the constant current sink. The bootstrap buffer is not used.

In both the above cases, leakage current in the protection diodes is diverted from the voltage measurement circuit, and so does not affect the shunt voltage passed out via **INT\_SIG\_BUS**.



#### 5.2.4.5 Selfcal and Selftest

##### Circuit Changes

As mentioned above, the internal circuitry is changed to perform these functions. The Input switching disconnects the I+ and I- lines from the input channel terminals. Current to test the Current PCB is sourced from the output stage of the Low Follower on the Ohms PCB, via the I+ line; and controlled by the Ohms constant current sink, via the I- line.

The shunt voltage is no longer referred to GND\_10. Instead, the low end of the shunt is switched to a special **LO\_SENSE** line, which provides the low input to the low follower. Relay RL101 on the Current PCB is energized during Selfcal and Selftest to perform this changeover. The voltage at the high end of the shunt chain is passed to the DC PCB via the INT\_SIG\_BUS line as in normal Current function.

In effect, the resistance of the shunt chain is measured by the Ohms function. All five ranges are calibrated and tested by this method. The DC arrangement is shown on the Test Setup Diagram in Section 2 (page 2-36 to 2-40).

For AC current the voltage at the high end of the shunt is passed to the ACV PCB for measurement. This arrangement is shown on the Test Setup Diagram in Section 2 (page 2-42).

##### Fuse Test

This is performed as part of Selftest. The instrument is programmed into the DC 10mA range, with the test current being drawn from the Ohms PCB. If the fuse is intact, the voltage measured on the INT\_SIG\_BUS will be positive, and a pass condition is registered. If it has blown, the voltage will be negative due to the Ohms constant current being forced to zero, indicating failure condition.

## 5.2.5 Analog-to-Digital Conversion

### 5.2.5.1 Functional Diagram

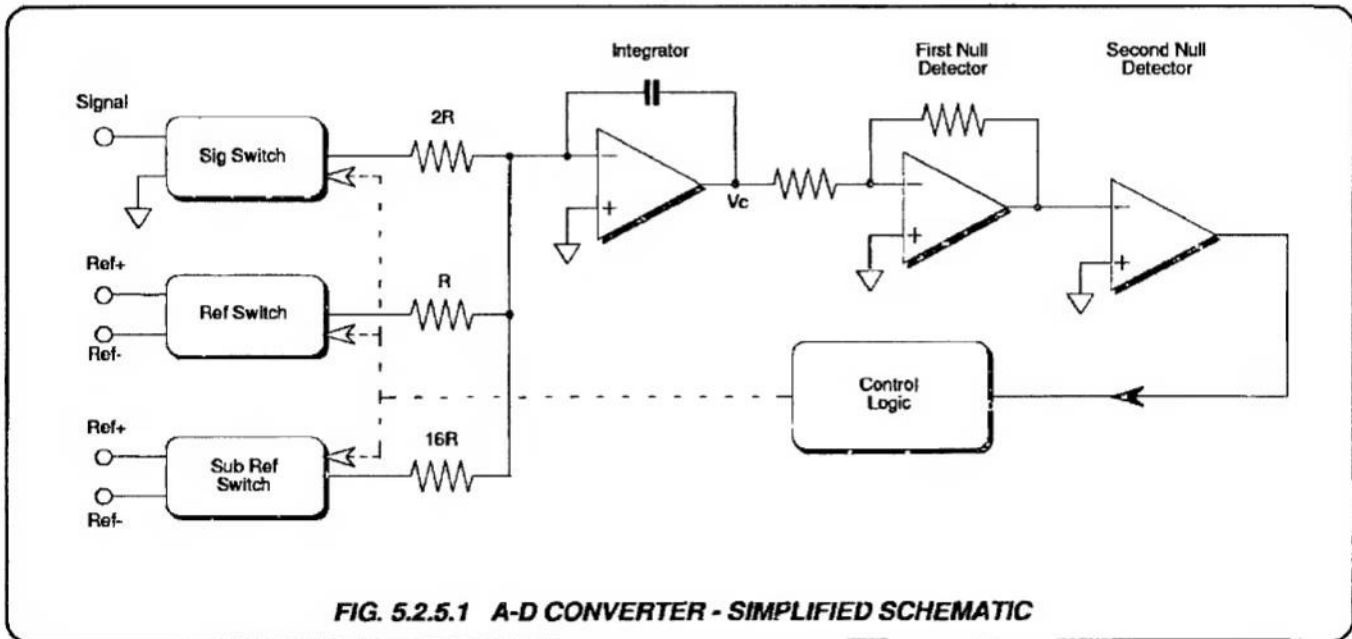

### 5.2.5.2 Introduction

The instrument converts conditioned analog signals to a digital form using a multi-ramp, multi-slope, integrating A-D. This provides:

1. High linearity - < 0.2ppm without adjustment;
2. Low noise of < 0.05ppm of full scale;
3. High speed - signal and reference are applied together simultaneously, greatly reducing the conversion time;
4. 100% overrange, giving a maximum discrimination of 1 part in 200 million;
5. Flexible operation - resolution (and hence speed) are programmable, from 5.5 digits at 1000 readings per second to 8.5 digits per second at one reading per 6 seconds.

A digital autozero system avoids the need for the more common sample-and-hold type of autozero circuit.

Multislope operation permits the integration capacitor value to be smaller than normally required for a more conventional circuit, greatly reducing problems due to dielectric absorption.

'Line locking' is incorporated to present a deep and narrow 60dB rejection notch, which is independent of the input amplifier response time and supports high data rates. This continuously-tracking notch combats line-related EMI, as the critical A-D timing waveforms synchronize precisely with the frequency of the incoming power line.

The control logic determines the parameters of the conversion, by counts and timings which are selected by the processor and transferred via the serial interface in four bytes of data. Timing, counting and control are executed by a custom 'ASIC' (Application-Specific Integrated Circuit), resulting in a design which offers both variable integration times and user-selectable resolutions.

The digital result of a measurement is transferred back to the processor via the serial data interface.

Reference switching errors are reduced to a constant value, which are subtracted from the reading by the instrument's microprocessor.



### 5.2.5.3 Reset

'Reset' mode replaces the more conventional analog 'Autozero'. It is imposed by the ASIC except when a conversion is in progress. The four phases of reset activate the converter to ramp through small excursions about zero, eliminating zero drift and holding the converter in a quiescent state. The ramps and timings are shown in Fig. 5.2.5.2.

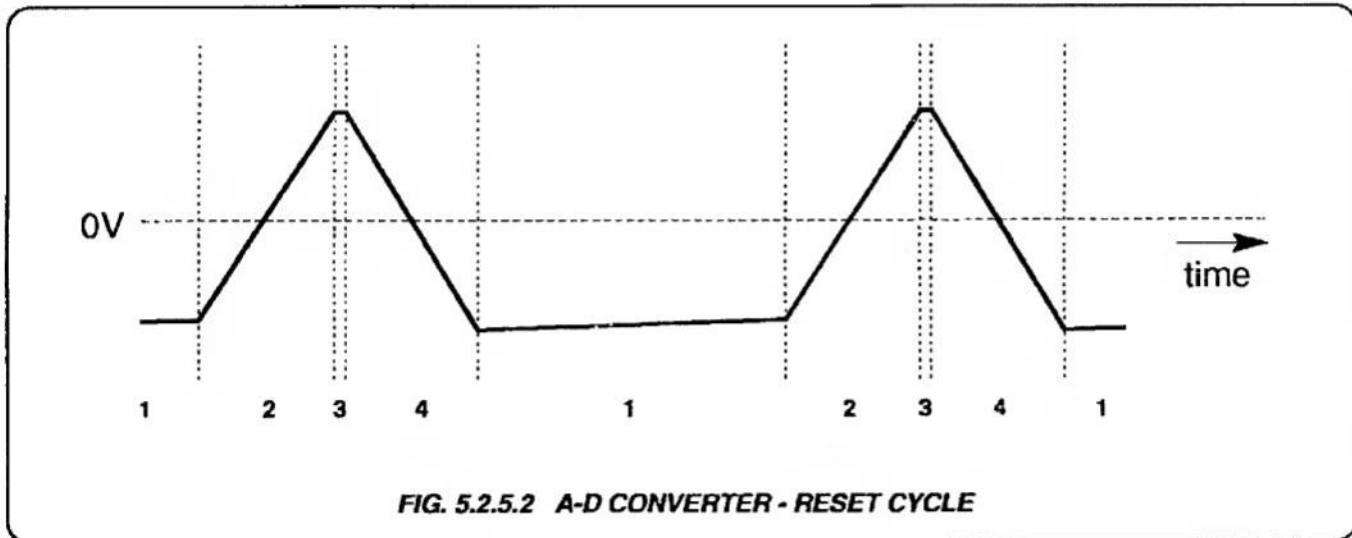

FIG. 5.2.5.2 A-D CONVERTER - RESET CYCLE

#### The Reset Cycle

There are four phases in the reset cycle, numbered on Fig. 5.2.5.2:

- ø1. Zero is applied to both Signal and Reference inputs. This time is set by the ASIC, and the slope is determined by the integrator drift (exaggerated on the diagram).
- ø2. Zero is applied to the Signal input, and  $-Ref/256$  to the Reference input. The integrator ramps up and crosses zero. The Null Detector has a standard delay, and for a fixed period after this, the ASIC continues to apply  $-Ref/256$ . These three times constitute the time of phase 2.
- ø3. Zero is applied to both Sig and Ref inputs as in phase 1 for a very short period, to guard against any overlap in switching. The integrator drifts during this time.
- ø4. Zero is applied to the Signal input, and  $+Ref/256$  to the Reference input. The integrator ramps down and crosses zero. The Null Detector has the same delay, and again the ASIC continues to apply the  $+Ref/256$  for a further fixed period. These three times constitute the time of phase 4.

The cycle is repeated, maintaining the integrator output near zero (within approx.  $25\mu V$ ). The overshoot in phases 2 and 4 is deliberately introduced to ensure a clean transition through zero. As can be seen from the diagram, the integrator output always reaches the same value at the end of Phase 4, due to the two fixed ramps, even though drift may occur in phase 1.

Because of its low amplitude and short timings, this reset waveform is difficult to view accurately.

#### End of Reset

The A-D continues in Reset mode until instructed to start a reading conversion. A separate control line (CI1-R), with its own optocoupler (U803-3/6), initiates the conversion.

5.2.5.4 Conversion Initiation

Triggering

Depending on the type of measurement trigger received, the instrument can be called upon to execute single or multiple readings, the latter being processed in some way to arrive at a 'measurement'. This could be as a result of an external trigger, a manual trigger (sample) or a trigger received over the IEEE 488 interface. The number of readings to be taken depends on the instrument state and the type of trigger received.

'Conversion initiate' Signal

For each reading required, the **Conversion Initiate** signal (CI-R) is set high to start a conversion on its rising edge. As a result, the A-D executes a Reset cycle, ensuring that the conversion starts from a known integrator output value. The cycle is terminated by the ASIC SIG lines being activated to apply the conditioned signal to the integrator input. The result of CI1-R is shown in Fig. 5.2.5.3 for a negative signal input.

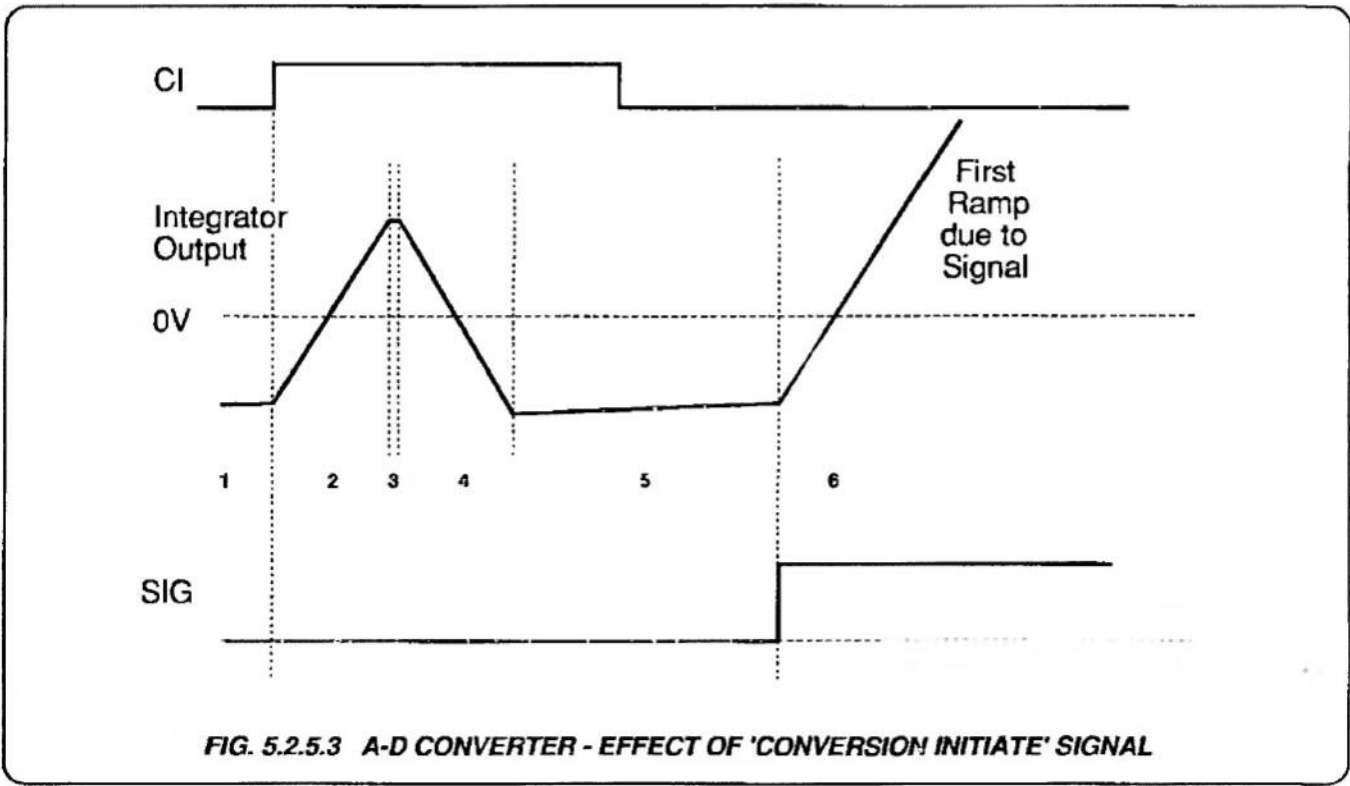

FIG. 5.2.5.3 A-D CONVERTER - EFFECT OF 'CONVERSION INITIATE' SIGNAL



## **Single and Multiple Ramp Conversions**

### **Notes**

Pages 5-30 to 5-35 illustrate examples of the forms of conversions used in the 1271. Because of the wide range of amplitudes and timings which are involved in the sequences, the waveforms given in the figures are not to scale - some exaggeration is required to show the changes.

The control signal waveforms are intended to illustrate sequencing only - in some cases there are several versions of a signal. Polarities and amplitudes in the figures are therefore not to be regarded as accurate.

### 5.2.5.5 Single Ramp Conversions

The integrator output and control signals for a single conversion with positive and negative inputs are illustrated in Fig. 5.2.5.4 and 5.2.5.5 respectively. Time starts at Phase 5 after the Reset initiated by the CI signal. There are several versions of the control signals, those shown in the diagrams indicate timing only, and not polarity.

#### Positive Signal Input

The phases in the conversion cycle for positive signal input are numbered on Fig. 5.2.5.4:

- ø5. Zero is applied to both Signal and Reference inputs, this is the final stage of CI.
- ø6. The positive signal is applied to the Signal input, with zero on the Reference input. The integrator ramps down for a fixed period.
- ø7. The signal is applied to the Signal input, with +Ref on the Reference input. This 'bias' is applied for a fixed period with Ref polarity determined by the state of the Null Detector. It is arranged for the integrator to ramp further away from null.
- ø8; ø9: Zero is applied to both Sig and Ref inputs to ensure that two references are not applied together.
- ø10. Zero is applied to Sig input and -Ref to the Ref input. The integrator ramps up and eventually crosses null. The Null Detector has the standard delay, and the ASIC continues to apply -Ref for a further fixed period. The integrator therefore overshoots.
- ø11. Zero is applied to Sig and Ref inputs for a fixed period. This 'wait' allows the dielectric absorption in the integrator capacitor to be recovered. Note that the conditions of phase 11 are applied three times.
- ø12. Zero is applied to Sig input and +Ref/16 to the Ref input. The integrator ramps down and crosses null. The Null Detector has the standard delay, the ASIC continues to apply the +Ref/16 for a further fixed period, and the integrator overshoots.
- ø13. Zero is applied to Sig input and -Ref/16 to the Ref input. The integrator ramps up and overshoots null, controlled by the Null Detector and ASIC delays.
- ø14. Zero is applied to Sig input and +Ref/256 to the Ref input. The integrator ramps down very slowly and crosses null. The integrator overshoots null, controlled by the Null Detector and ASIC delays.

Note that the time 'T' is fixed, as are the durations of phases 11, 12, 13 and 14. There is also the fixed Null Detector delay, and a fixed overshoot delay after null is detected in phase 10. Bias is applied during phase 8.

#### End of Conversion - RTX Signal

The conversion is now complete and the A-D reverts to Reset mode. To signify the end of the conversion the ASIC sets RTX high. Data may now be shifted out of the A-D via the serial interface. RTX remains high until the next CI is received.

Observe that at the end of phase 14 the integrator output is negative due to the same delays and +Ref/256 as at the end of Reset phase 4, so it is back where it started before the conversion. Hence the accumulated amount of the references applied is a measure of the signal applied.



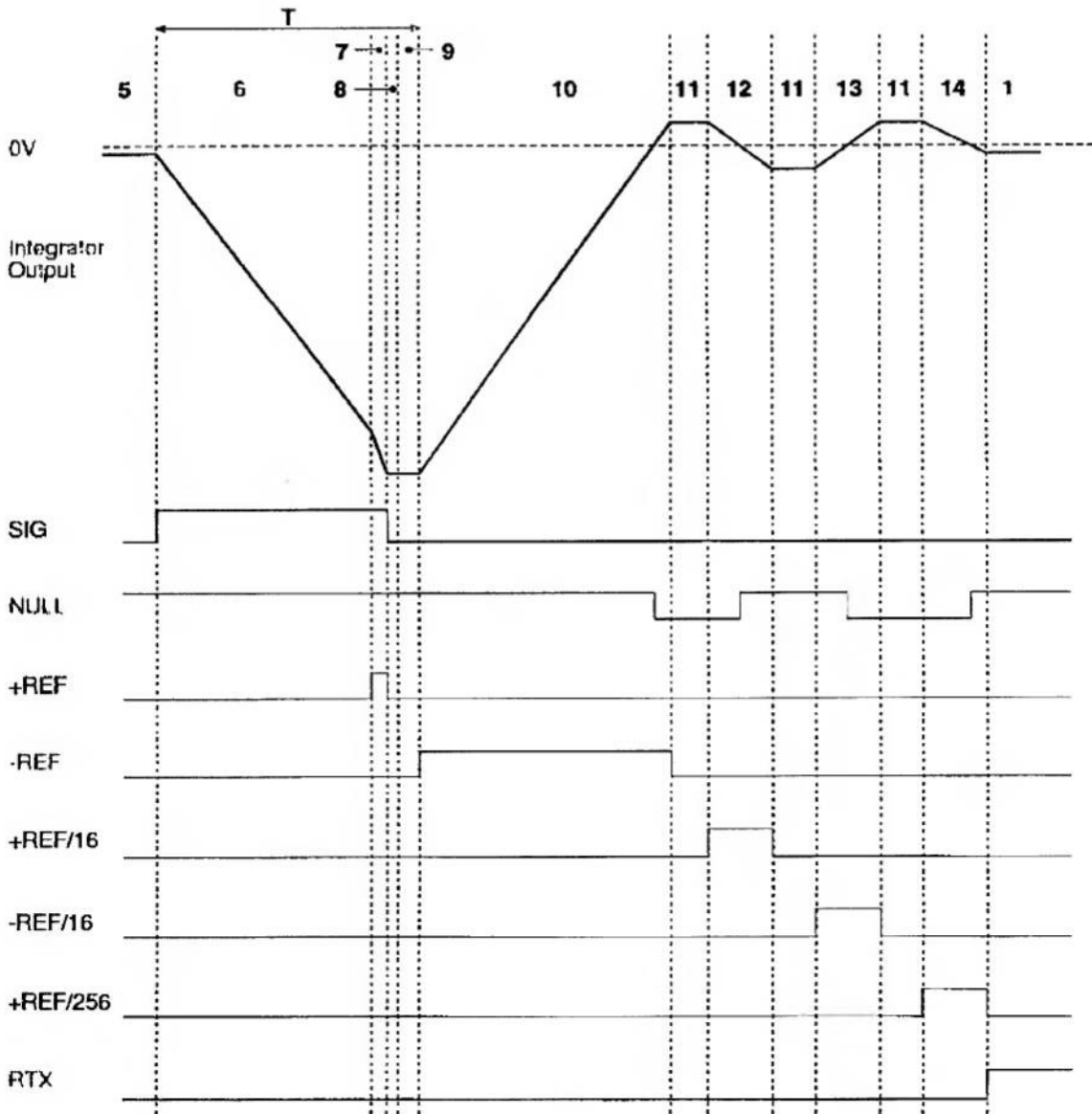

FIG. 5.2.5.4 SINGLE RAMP CONVERSION - POSITIVE INPUT

**5.2.5.5 Single Ramp Conversions (Contd.)**

**Negative Signal Input**

The phases in the conversion cycle for negative signal input are numbered on Fig. 5.2.5.5. The conversion is subtly different, because of the integrator output starting and finishing at a negative value. This shifts some of the null crossings, and the general waveform is not merely an inversion of that for the positive input. Nevertheless, the principle of operation and sequence of phases remain the same.



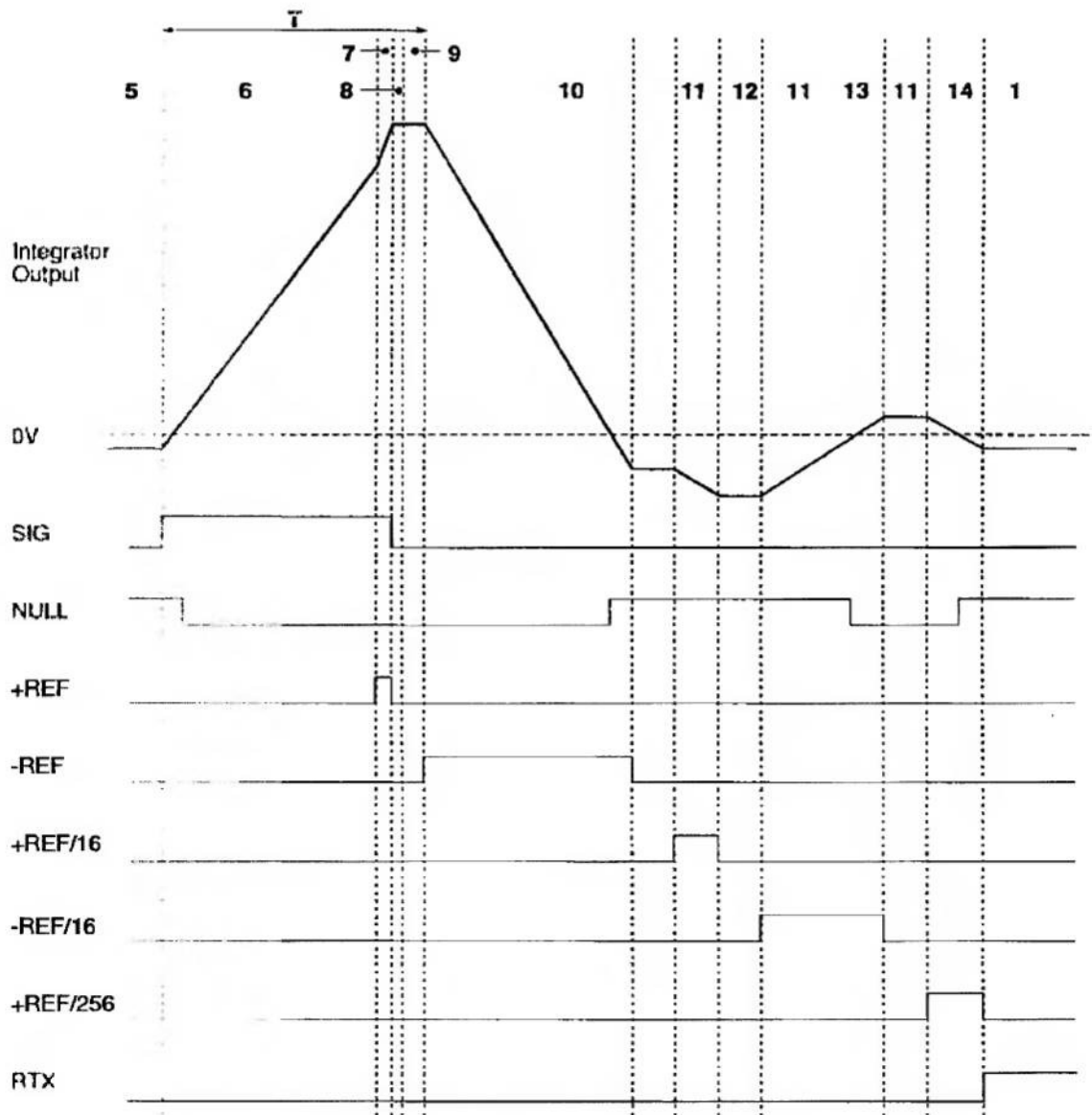

FIG. 5.2.5.5 SINGLE RAMP CONVERSION - NEGATIVE INPUT

### 5.2.5.6 Multiple-Ramp Conversion

#### Sequence of Phases

The integrator output and control signals for a multi-ramp conversion with positive input is illustrated in Fig. 5.2.5.6.

- ø1 to ø5** These are as described earlier for Reset.
- ø6 and ø7** These are the same as in the single-ramp conversion.
- ø8 to ø14** These are the same as in the positive single-ramp conversion.
- ø15** This is similar to ø8 for the single ramp; but the positive input signal is reapplied to the Signal Input instead of zero. The slope of the ramp is the same as in ø6.
- ø16** Signal and Reference are applied. The polarity of the chosen reference is such as to ramp back towards null. The ramp overshoots null due to null detector and ASIC delays.
- ø17** Signal only is applied. No 'wait' time is required between ø16 and ø17, as the reference is not applied in ø17, and so there is no possibility of shorting two references together. The slope of the ramp is the same as in ø6.

The cycle of phases 17, 7, 15 and 16 continues for as many ramps as are required for the programmed configuration. The final cycle is the same as the single-ramp version.

Once again, the accumulated amount of the references applied is a measure of the signal applied.

#### Integrator Output Waveshape

As the magnitude of the input changes, so does the shape of the integrator waveform.

At full scale the ramps are symmetrical and of equal height. As the signal is reduced the ramps begin to lean over with the null point moving to the left. The first ramp is reduced to about half the size of subsequent ones, and they are not all the same size. This is normal behavior, and is not indicative of a fault.

#### Counting

The rules for counting the amount of reference applied are quite simple:

1. Counting occurs whenever a reference is applied.
2. The count is **up** for negative references; **down** for positive references.
3. If Ref is applied the count increments in units of 256.
4. If Ref/16 is applied the count increments in units of 16.
5. If Ref/256 is applied the count increments in units of 1.

This ensures that even with overshoot the correct result is obtained. A normal 32-bit up/down counter within the ASIC is used, that is reset to zero by the signal CL.



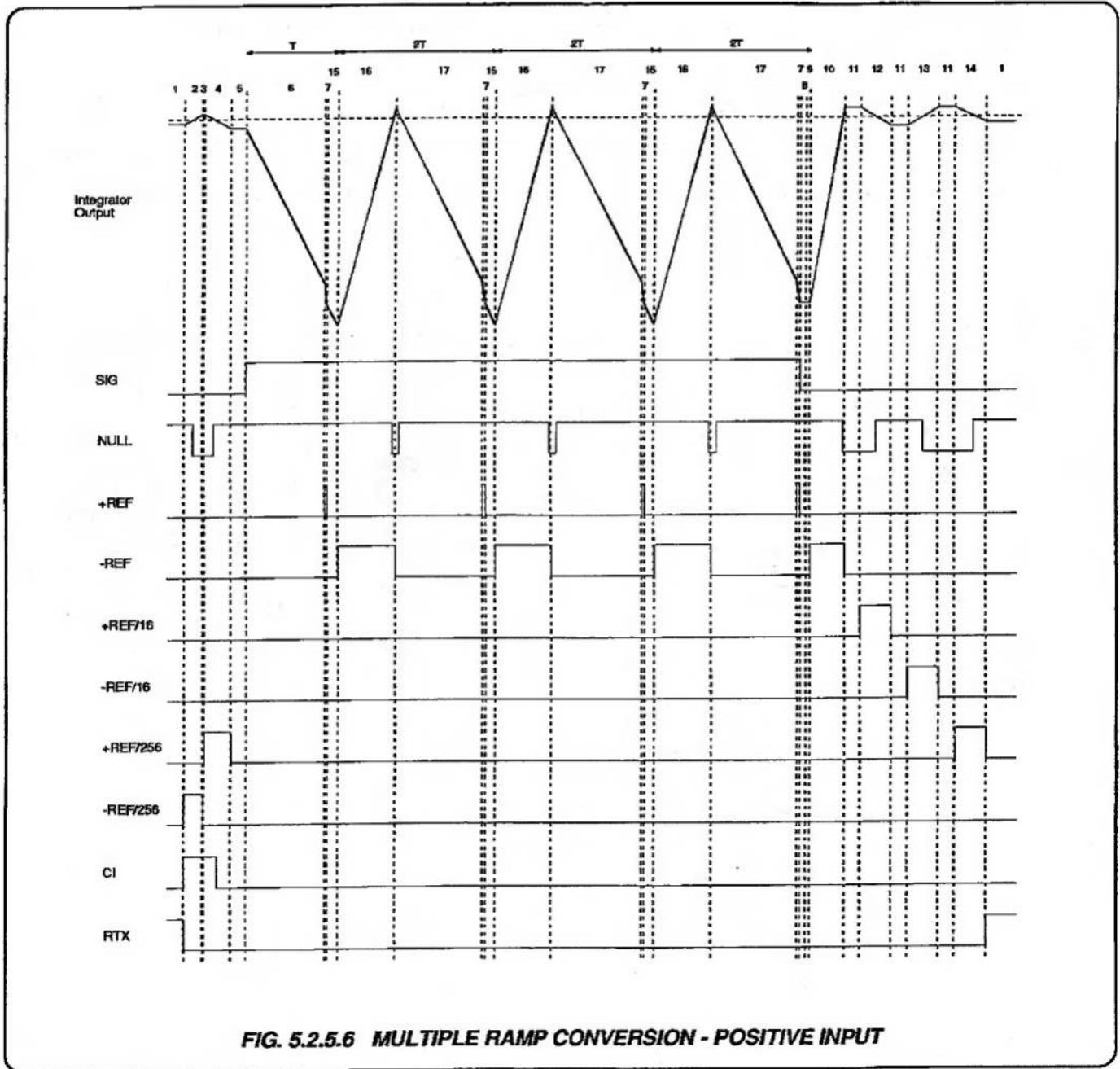

FIG. 5.2.5.6 MULTIPLE RAMP CONVERSION - POSITIVE INPUT

**5.2.6.1 Reference Modules**

**Module Description**

The reference used in the analog to digital conversion is derived from specially conditioned zener reference modules. Each contains the reference device and its associated circuits.

The modules are stable to within  $\pm 3$ ppm per year, produce noise of less than 0.1ppm, and have temperature coefficients of better than 0.1ppm/ $^{\circ}$ C. This temperature coefficient is held over a very wide temperature span of 0 $^{\circ}$ C to 70 $^{\circ}$ C, and the references exhibit negligible temperature shock hysteresis.

**5.2.6.2 Reference Generation**

**Master Reference**

(Circuit Diagram DC400866 Sheet 4; page 11.2-5)  
 The -7V reference is amplified to -10V by REF AMP U403. This is inverted by a flying capacitor REF INVERTER U404 to produce a 10V reference. The positive and negative references are buffered by U407 and U408 respectively.

Gates U502-16 and U503-1 compensate for the effects of the attenuator switching gates at the A-D input.

(Circuit Diagram DC400866 Sheet 5; page 11.2-6)

The outputs from Q408 and Q409 are the two compensated reference signals '+VREF\_COMP' and '-VREF\_COMP'. These are fed to the REF SWITCH U502/U503 and SUBREF SWITCH U504/U501, which select the A-D reference levels under the control of ASIC U509.

**Ohms Reference**

REF BUFFER U406 buffers the averaged output from the reference modules to generate OHMS\_REF, which is passed out via J107-11 to the Ohms PCB at PL43-11. This level is also passed, as the 'CAL REF' signal, to the Selfcal Multiplier circuit (p11.2-8). During Selfcal and Selftest CAL REF is switched as the input to the Error Amplifier of the Selfcal Multiplier to provide its DC reference voltage.

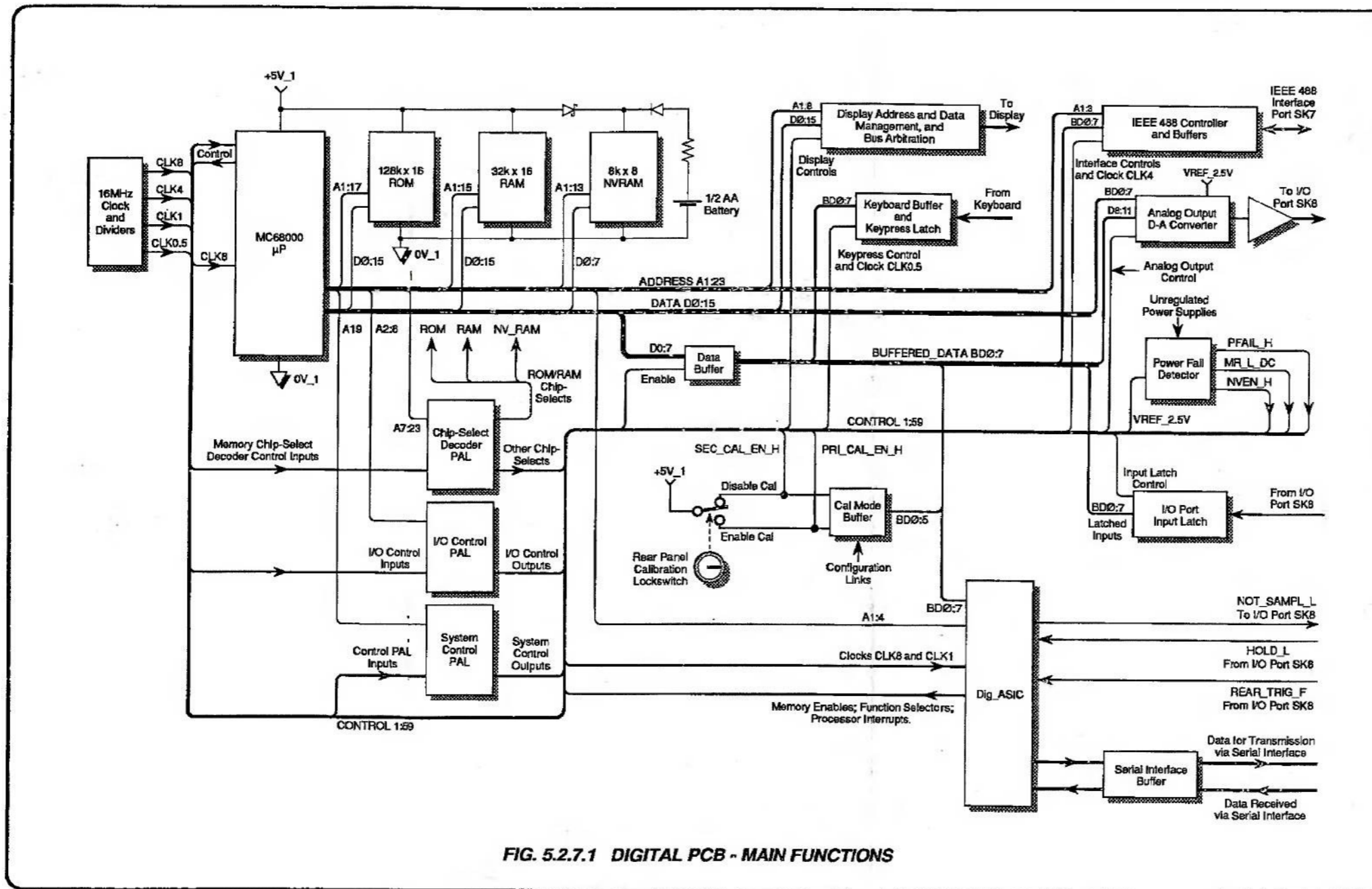

FIG. 5.2.7.1 DIGITAL PCB - MAIN FUNCTIONS



## 5.2.7 Digital Control

### 5.2.7.1 Functional Block Diagram

Fig. 5.2.7.1 opposite shows the main groups of functional circuits on the Digital PCB.

### 5.2.7.2 Processing, Memory and Organization

#### Clocks

(Circuit Diagram DC400901 Sheet 1; Page 11.4-2)

All synchronizing clocks used on the Digital PCB are derived from 16MHz crystal oscillator Y101. Four are required; produced by division in U101:

- CLK8: 8MHz for the Processor and Digital ASIC (p 11.4-3);
- CLK4: 4MHz for the IEEE 488 I/F Controller (p 11.4-5);
- CLK1: 1MHz for the Digital ASIC (p 11.4-3);
- CLK0.5: 500kHz for the Display Controller (p 11.4-4).

#### Processor

(Circuit Diagram DC400901 Sheet 1; Page 11.4-2)

The instrument is internally controlled by a 68000-series microprocessor. It ultimately translates all information, from the front panel keys and IEEE 488 interface, into control signals which determine the instrument's operation.

#### Data Transfers

Normal data transfers are processed via all address lines A1:23 (Address Bus) and all data lines D0:15 (Data Bus), using the inherent 68000 word and byte divisions and strobes. Other control signals in and out of the processor are grouped in the circuit diagrams as a 'Control Bus', but this is merely for clarity - the lines are distributed on the PCB.

Different devices need different access times, and the processor requires read/write cycles to be terminated by the handshaking device to achieve maximum operating speed. The instrument accounts for three different access times:

- 250ns: Normal RAM, EPROM, ASIC and Interrupt Acknowledge;
- 500ns: IEEE 488 Controller, NV RAM, Display and I/O Port;
- 1µs: Switches
- 2µs: Analog-Output D-A.

#### Memory Assignment

(Circuit Diagram DC400901 Sheet 1; Page 11.4-2)

EPROMs U103 and U104 hold the 128k x 16 of operating program and fixed data; RAMs U112 and U105 contain 32k x 16 of workspace.

U106 is a low-power static 8k x 8 RAM which is permanently powered: either by the +5V supply, or by 1/2 AA battery BT1 when the instrument is switched off. Its 'non-volatile' memory is occupied by constants which are stored during calibration, and subsequently used to correct readings when in normal use.

#### Memory Access

All memory is held in 8-data-bit devices.

The EPROM chips are device-enabled by the Decoder PAL U110 from addresses A20:23. U103 and U104 are chip-enabled together by A19, and addressed via lines A1:17. Data bytes are read in parallel by simultaneous addressing; U103 provides the 'upper' byte onto data bus lines D8:15, and the 'lower' byte is read from U104 onto D0:7.

The workspace RAM chips are selected by the Decoder PAL U110, and addressed via lines A1:15. Data bytes are read in parallel by simultaneous addressing. For RAM data, U112 is served by the 'upper' byte D8:15 and U105 by the 'lower' byte D0:7. Device-enable and read-write are selected via the control bus.

The non-volatile RAM is also selected by the Decoder PAL U110, and addressed via lines A1:14. For RAM data, U106 is served by the 'lower' byte D0:7. Device-enable and read-write are selected via the control bus, and write is inhibited unless calibration is enabled. NV RAM (U106; page 11.4-2) is divided into three areas:

1. Primary Calibration Constants (External Calibration);
2. Secondary Calibration Constants (Self Calibration);
3. User NV (Input Zero, Password, Bus Address etc.).

The Primary Calibration Constant area is protected against unauthorised Write access by the rear panel Cal/Run keyswitch. Secondary Calibration Constants and User NV, by necessity, are not keyswitch protected.

#### Control Decoding

(Circuit Diagram DC400901 Sheet 1; Page 11.4-2)

Three PALs: U107, U110 and U111, manipulate the various signals which are used to control instrument operation. Generally, U110 deals mainly with memory selection and calibration processes; the inputs to U111 are decoded to select devices other than memory. U107 operates mainly on handshake signals to and from devices which require longer access times.

#### Buffered Data Bus

(Circuit Diagram DC400901 Sheet 2; Page 11.4-3)

The lower data bus D0-7 is connected to the two-way buffer U201 to provide the Buffered Data Bus BD0:7. This is used to access several devices: Keyboard, Cal Mode Buffer, Digital ASIC, IEEE 488 Interface Controller, Analog Output D-A Converter and the I/O Port. U201 is enabled by EN\_BUF\_L, and its direction is controlled by signal BR\_HW\_L.



### 5.2.7.3 Digital ASIC

The Digital ASIC (U203 on page 11.4-3) is a 68000 support chip for digital multimeters. It interfaces via 16 read-write registers and an interrupt handler.

#### Functions

(Circuit Diagram DC400901 Sheet 2; Page 11.4-3)

1. 68000 bus time-out for one or more wait state pairs (DTACK). Bus error generation on invalid address time-out (BERR).
2. 68000 reset power delay PFAIL to RESET.
3. Switching counter 1 to 256ms delay gives interrupt.
4. Tick interrupt 10ms or 100ms period.
5. Internal counter - free-running for internal triggers 0s to 10s: 10-bit with four prescales (10 $\mu$ s; 100 $\mu$ s; 1ms and 10ms). Software triggers are used for delays greater than 10 seconds.
6. Delay counter - one-shot to delay conversion after trigger 0s to 10s: 10-bit with four prescales (10 $\mu$ s; 100 $\mu$ s; 1ms and 10ms). Software delays are used for intervals greater than 10 seconds.
7. Serial Interface - two-way communication between the 68000 and the Analog Sub-System.
8. Measurement time-out interrupt if the A-D Converter locks up.
9. Write enable for non-volatile memory; and lockout circuit to detect illegal access.
10. Trigger conditioning:
  - GET from IEEE 488 interface or front panel SAMPLE key.
  - TRIG from rear panel BNC socket.
  - HOLD from I/O Port.
  - Internal interval counter.
11. 68000 interrupt handler - interrupts from serial interface, triggers and external pins (NMI; GPIA; ERR; FPINT; RTCINT).

### 5.2.7.4 Conversion Initiate (CI\_R)

#### Triggers

Firmware determines the way triggers are treated in the digital ASIC trigger conditioning circuit. Triggers may be disabled, cause an interrupt, or produce CI\_R depending on conditions. The maximum rate at which the analog sub-system can respond to CI\_R's is determined by the mode of the A-D converter and the need to collect measurement information via the serial interface between triggers. Three sources of triggers are:

**Internal:** Interval Counter - Hardware or Software

**External:** TRIG\_F - rear Trigger BNC connector.

GET\_R - from the IEEE bus.

SAMPLE - from the Front Panel key

A timer in the digital ASIC produces CI\_R (20-40 CLK1 periods) from the various triggers.

Internal triggers are generated by the Interval Counter in the digital ASIC at a rate controlled over the data bus by the processor. Where the trigger period is less than 10 seconds a programmable free running counter produces 'direct' triggers at a rate set by the processor. For trigger intervals greater than 10 seconds, 'indirect' triggers are produced by software in response to RTX\_R.

External triggers are conditioned; the conditioned triggers causing either an 'immediate' or 'delayed' trigger, or an interrupt, depending on the configuration set by the processor. In the case of an interrupt, the trigger is eventually produced from the interval counter via software.

If the interval between two external triggers is too short, the second is stored and acted upon at the earliest opportunity. If repetitive external triggers occur above the maximum rate allowed by the set configuration, triggering continues at the maximum possible rate and 'Trigger Too Fast' is flagged. The processor signals this to the I/O port via the data bus and U208-6 (page 11.4-3).

To summarize trigger forms:

1. Internal triggers - Interval counter:
  - Hardware: < 10 Seconds
  - Software: > 10 Seconds
2. External triggers - Software
3. Direct triggers come from hardware.
4. Indirect triggers come from software.
5. Delayed triggers pass through the Delay Counter (max 10 Second delay).
6. Immediate triggers by-pass the Delay Counter.

In order to offer external control facilities (other than the IEEE bus), an I/O Port has been fitted in the instrument rear panel. This could be used; for example: in conjunction with the Rear Trigger input in a process control system.

The rear Trigger input is a BNC connector on the rear panel.



### 5.2.7.5 Display Management

(page 11.4-4)

Data to be displayed on the front panel is stored in RAM. The processor employs 'Bus Arbitration' so that the Display Management System can gain access to this information.

#### Display Data Access

When Display Management requires data, it asserts BR\_L (Bus Request). In reply, the processor asserts BG\_L (Bus Grant) to indicate that control of the bus will be released at the end of the current processor cycle. The end of the cycle is signalled to each of the control PALs by AS\_L being cleared, which is decoded with BG\_L by U107 (System Control PAL) as ST\_BG\_L.

This signal causes the Display Management system to take control, which it acknowledges by asserting BGACK\_L (Bus Grant Acknowledge).

Display Management now has control of the bus. Signal DMA\_L (Direct Memory Access) enables the RAM, and data is extracted using the Address and Data buses. Control of the bus is returned to the processor when BGACK\_L is cleared.

#### Anode Data

DSHFT\_R clocks anode data into the display's 100-bit serial register (page 11.3-1) as seven 16-bit words via DDATA\_H. DLTCH\_H latches this pattern when the next pattern is shifted in. The display is scanned by walking a Logic-1 along the 20-bit grid register, one step for each 7-word set of anode data. The Logic-1 is clocked by DLTCH\_H.

#### DDATA\_H

U309 and U310 form a 16-bit serial-in/parallel-out register to provide the serial data stream DDATA\_H.

#### RAM Addressing

U304 is a +16 counter whose output DMA\_REQ\_H signals completion of each word to U305 and the Bus Arbitration System. U305 divides by seven and provides a word count for RAM addressing on WRD $\emptyset$ , WRD $\emptyset$  and WRD $\emptyset$ .

The output from the +20 counter U306/U307 is a character (grid) count used for RAM addressing via octal buffer U303.

The divide-by-16 counter U304 is clocked by CLK0.5 through U302-8, U311-4 and U308-4. At the count of 15 the carry out bit U304-15 goes high setting DMA\_REQ\_H at U312-12. On the next edge of CLK0.5, BR\_L is set at U312-8 to request bus control. While BR\_L is set, the CLK0.5 input is disabled by U313/U302 and all counting and shifting is stopped.

The processor asserts BG\_L but ST\_BG\_H stays low until AS\_L is cleared. When AS\_L goes high at the end of the processor cycle, ST\_BG\_H goes high and U313-6 is clocked low by CLK8 to assert BGACK\_L.

As well as being the response to BG\_L, BGACK\_L provides an enable for the parallel-in/serial-out Display Data Shift Registers U309/U310.

CLK0.5 remains inhibited, now via U313-5, U311-1 to U302-12. U313-5 also sets U313-12 high, and on the next CLK8, DMA\_L is set at U313-8. This clears BR\_L.

DMA\_L enables RAM U112 and U105 via SEL\_RAM\_L from U110-19 (page 11.4-2). DMA\_L also enables the address buffer U303, so the address set by WRD $\emptyset$ :2 and CHR $\emptyset$ :4 is applied to the address bus. The first of the seven anode data words is thus loaded into U309/U310 via the data bus.

In response to BGACK\_L the processor clears BG\_L, and hence ST\_BG\_H.

U313-9 going low removes the inhibit on CLK0.5 at U302-12, causes DMA\_L to be cleared at U313-8, and thus removes the enable on address buffer U303.

DSHFT\_R is produced from CLK0.5 via U302-8, U308-4 and U311-10. Sixteen edges of DSHFT\_R load the U309/U310 data word into the display anodes serial register. The series of sixteen CLK0.5 clocks also produces another DMA\_REQ\_H at U304-15, so the DMA cycle is repeated.

U305 counts DMA\_REQ\_H to generate the seven-word count, U305-15 incrementing the character counter U306/U307 after each seven words, latching the pattern on the Front Panel. This causes the Logic-1 in the display grid register to be shifted to the next grid by DLTCH\_H via U308-12.

WRD1, WRD2 and CLK0.5 are gated by U207-11 and U312-5 to produce DBLK\_H which blanks the display while the last two of each group of seven words are being loaded.

DG20\_H is produced at U308-8 from U307-15 after each set of 20 characters (140 words) to load a Logic-1 into the display grid register.

After a system reset, the display is blanked for approx. 500ms by R306/C302 to allow the RAM to be re-initialized by the processor; and to allow the display registers to synchronize with the Display Management address counters.

Display scan is inhibited by the action of DBLK\_H in the display circuit.

The facility for display blanking by DOFF\_H is not used in the 1281. DOFF\_H is cleared by the processor via the data bus and U208-19 (page 11.4-3) at power up reset.



### 5.2.7.6 Keyboard Interrupt (pages 11.4-2 to 11.4-4)

KB5 from the keyboard encoder sets the Key Press Latch by clocking U302-3. This signals FP\_INT\_L to the digital ASIC interrupt Handler at U203-39 (page 11.4-3).

The digital ASIC sets the interrupt level '2' on IPL1 and IPL0/2 (U203-40/41) to indicate an interrupt to the processor.

The processor compares the interrupt level with its internal mask. Assuming that the interrupt is of higher priority, the processor completes the current instruction then sets its mask at level 2.

The processor then sets the interrupt level 2 on A1-A3, asserts AS\_L and sets R\_H/W\_L high. At the same time FC0\_H, FC1\_H and FC2\_H are set, asserting IACK\_L at U107-19 (page 11.4-2).

R\_H/W\_L and AS\_L with IACK\_L at U203-4/57/58 cause the digital ASIC to output the relevant exception number on BDØ:7. Access time-out is by U107 setting UIDTACK\_L, which drives the processor via U110-16.

The processor is now in an exception cycle. From ROM it fetches the exception vector indicated by the digital ASIC. The two vector words hold the first of a series of addresses which contain the instructions to read the front panel keys.

(Note: should an interrupt of higher level occur (such as ERR\_L from in-guard), the processor will terminate the read from the front panel.)

The processor places the 'Read Front Panel' address on the address bus. This is decoded to assert RDFP\_L by the address decoder U111 at pin 19. RDFP\_L carries out the following actions:

1. resets the Key Press Latch by U302-1;
2. enables the Keyboard Buffer U301;
3. causes DTACK\_L to be asserted after 500ns via the digital ASIC access timeout circuit.

The Keyboard Buffer places the encoded key number at KBØ:5 onto the buffered data bus BDØ:7. The two-way buffer U201 (page 11.4-3) has been enabled by AS\_L (IACK.AS\_L) and its direction has been set by R\_H/W\_L. The keyboard code is thus passed via DØ:7 to the processor which takes appropriate action determined by the particular key which was pressed.

### 5.2.7.7 I/O Port Sk8

The I/O Port is a 'D' connector allowing the following TTL compatible inputs and outputs.

#### Inputs:

##### HOLD\_L

Input to the digital ASIC which may be used to disable triggering.

##### TRACK\_H; SAVE\_F

Not used - Track and Hold options are not fitted in the 1281.

##### REAR TRIG

Trigger input via SK9 to the digital ASIC trigger conditioning circuit.

#### Outputs:

##### DATA VALID\_L

Indicates that outputs are valid.

##### TRIG TOO FAST

Indicates missed triggers.

##### HIGH LIMIT\_L

Asserted when the applied input signal is more positive than a limit preset via the instrument keyboard.

##### LOW LIMIT\_L

Asserted when the applied input signal is more negative than a limit pre-set via the instrument keyboard.

Note: The above outputs are driven by the processor via latch U208 on the buffered data bus. U208 is enabled by WR\_LTCH\_L from address decoding (U111-16, page 11.4-2). When limits are set they are stored in the user area of NV RAM.

##### NOT SAMPL\_L

Asserted between measurements to indicate that the input signal may be changed. This output is an inversion of the Digital ASIC output SMPL\_L derived in the trigger conditioning circuit.

##### ANALOG 0V

Separate ground to minimise processor noise on the Analog output.

##### ANALOG O/P

DC level via the D-A converter. The output is bipolar with 2V representing full scale input on any range.



### 5.2.7.8 Analog Output

Analog output voltage is derived from measurement data stored in RAM (corrected by calibration constants). The processor writes data to the D-A convertor U205 on BDØ:7 and D8:11. Data is latched into the DAC by SEL\_WORD\_L (UDS\_L and LDS\_L combined at U111-15 *page 11.4-2*). U205 is selected by WR\_DAC\_L from address decoding U111-13.

When all the data is Logic-1, the Analog Output is -2.45V. All data at Logic-Ø produces +2.45V. An output of 0V is theoretically produced for inputs between hex 7FF and hex 8ØØ. In practice the output, although linear, is initially offset and requires calibration.

D201 provides a +2.45V reference to the 'R/2R' DAC. The DAC's Analog ground is connected to current mirror U206-1. U206-7 is a conventional inverting amplifier which sums the DAC output with the mirrored analog ground current from the DAC. This provides bipolar operation and output drive.

R205 protects U206-7 output, C203 and C205 prevent oscillation and D202-D205 are clamps. The Analog output is filtered by R205 and C204.

### 5.2.7.9 IEEE Interface

The IEEE controller (GPIA) U401 is connected to the IEEE bus via the buffers U402 and U403. Data is passed to and from the GPIA on the buffered data bus. Note that BDØ connects to D7, BD1 to D6 etc.

The GPIA is addressed via A1-A3, and runs on CLK4 to maintain bus handshake speed. It is enabled by SEL GPIA\_L, derived from U111-18 (*page 11.4-2*) and read/write is selected by BR\_HW\_L from U107-17. LWR\_L from U109-3 must also be asserted for the processor to be able to write to the GPIA.

When a valid Group Execute Trigger is received over the IEEE bus, it is transferred via the buffered data bus to U208 for decoding, then passes as GET\_R from U208-16 to the digital ASIC. If triggers are allowed, CI\_R is produced to initiate a measurement. Interrupts generated at U401-9 (GPIA\_INT\_L) are fed to the interrupt handler in the digital ASIC.

The buffers U402 and U403 are selected to Send or Receive by the GPIA U401-21. Additionally, U403 may be switched to controller mode by U401-30 (If for example there was a requirement for the 1281 to control its own 'CAL'). Special firmware would be required to employ this facility.

The GPIA has some internal de-bounce capability but extra provision has been made by fitting filter R401/C401 and R402/C402 to avoid problems which could arise due to external noise on IFC and REN.



Fig. 5.2.8.1

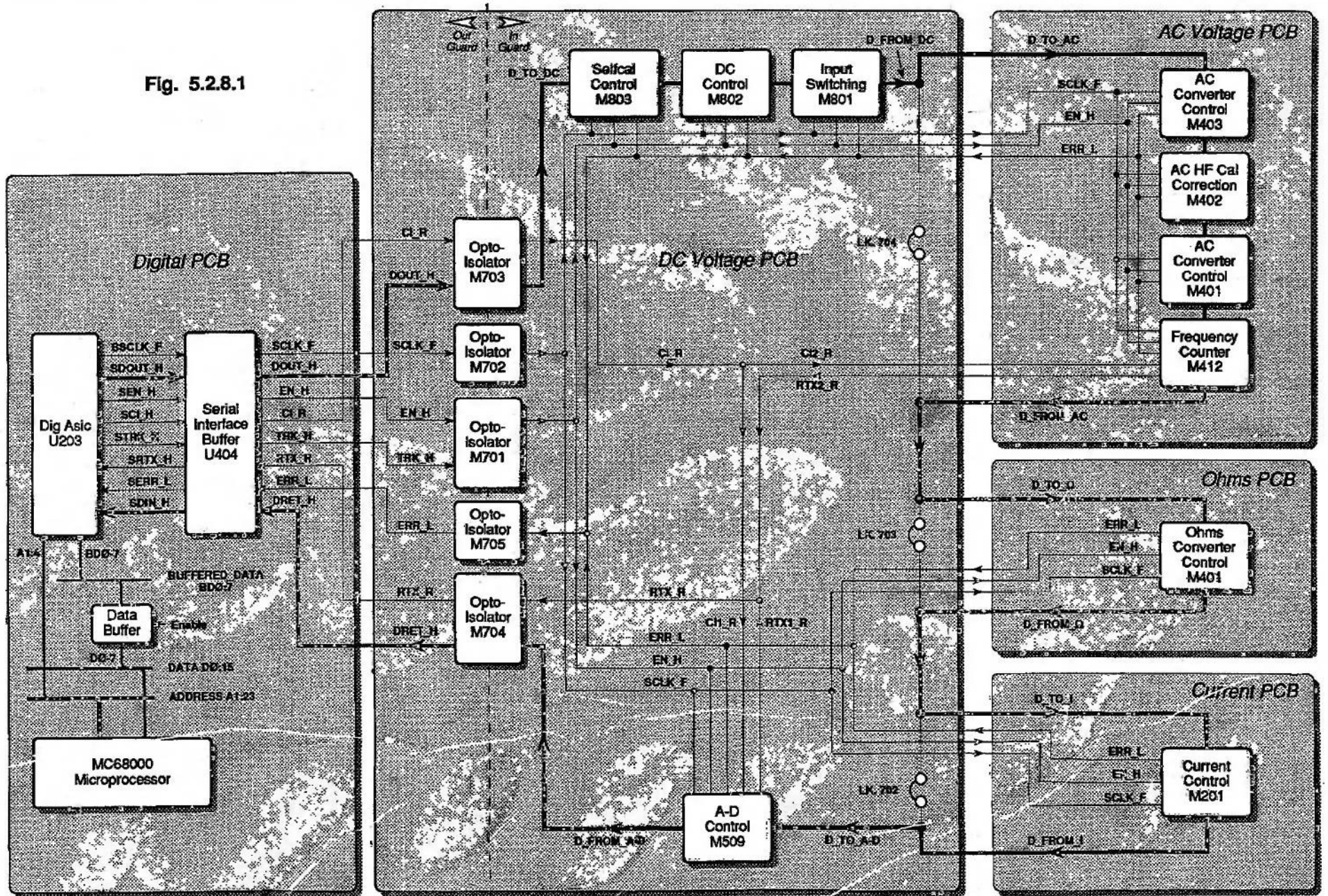

FIG. 5.2.8.1 SERIAL INTERFACE FUNCTIONAL LOOP



## 5.2.8 Serial Data interface

### 5.2.8.1 Functional Block Diagram

Fig. 5.2.8.1 (opposite) shows the elements and routing of the Serial Data Interface.

### 5.2.8.2 Need for a Serial interface

If the analog control signals and the necessary analog status signals were to be passed through the guard plane, each through its own dedicated isolator, then more than 50 isolators would be required. This would impose space penalties and introduce intolerable capacitive coupling and leakage between in-guard and out-guard circuits.

By passing a stream of data around an out-guard/in-guard serial loop, which needs only two isolators, the total number of active devices is reduced to seven (the TRK\_H signal is not used in the 1271). This includes provision for two asynchronous signals (not directly connected with interface transfers) and three interface control signals.

### 5.2.8.3 Interface Control

#### Processor Control of the Interface

The Interface Controller is incorporated into the Digital ASIC. The 68000 processor controls the interface using A1:4 and DB0:7, together with address decodes SEL\_ULA\_L, LDS\_L, R\_HW\_L and AS\_L. Signal UDTACK\_L handshakes acknowledgement of sufficient access time (250ns).

There are three main states of the interface:

- WAIT:** The interface is quiescent, awaiting instructions from the processor.
- WRITE:** The processor commands a change of instrument analog state via the interface.
- READ:** Status data is passed back to the processor from the analog circuits.

The processor instructs the Interface Controller to change the state of the interface by writing to the ASIC's command register over the buffered data bus BD0:7. The controller can find out the interface state and any status information by reading the ASIC's status register via BD0:7.

The Interface Controller can instruct the ASIC to request a processor interrupt via the IPL0:2 lines. When requested the processor responds by returning the same priority level via the FC0:2 lines. When the processor reaches the interface interrupt in the interrupt queue, it services it by setting IACK\_L low at the ASIC. This acts as a chip-select, and the interrupt data is read back to the processor via the buffered data bus. As a result the processor carries out the next step in the write or read cycle.

#### Power-up and Reset

The ASIC is placed into Reset condition at power-up. When it is released from reset, at this or any other time, the Interface Controller places the interface into the WAIT state. This causes all the in-guard Tx/Rx devices to take their serial registers off-line, and they become 'transparent' to any signals on the serial path, which effectively bypasses them.

From this point the processor controls the state of the interface, and via the interface, the instrument analog state.

#### Changing the Instrument Analog State

The processor commands the interface state to WRITE and a write cycle begins. Control data to be transmitted via the interface is passed over the buffered data bus in 'Long Words' (32 bits). This data is transferred over the interface in a series of 64-bit groups, each comprising four bytes of true data interlaced with four bytes of complement data. The ASIC implements the word-group conversion. The in-guard Tx/Rx devices are set to receive.

#### Obtaining Measurement and Status Data

To do this the processor commands the interface state to READ and a read cycle begins. The in-guard Tx/Rx devices are set to transmit. The 8-bit registers become transparent on the signal path. Measurement or status data to be returned from the A-D ULA and Frequency ULA are loaded into their serial registers, and are transmitted through guard to the digital ASIC.



#### 5.2.8.4 Data and Control Lines

##### **DOUT\_H and DRET\_H**

The Digital ASIC is buffered from the opto isolators on the DC PCB by U403 (page 11.4-5). From Fig.5.2.8.1 it can be seen that the data line loops around all the Tx/Rx devices in the analog sub-system, entering via the opto-isolator U803 on the DC PCB as DOUT\_H, and returning via U805 as DRET\_H.

##### **SCLK\_F (Transfer Clock)**

Clock pulses on the SCLK\_F line are fed to all Tx/Rx devices through U802 on the DC PCB. Their purpose is to clock the data round the serial loop.

##### **EN\_H (Transfer Enable)**

This signal goes high to enable data transfers around the loop. The condition of the serial data line during the first four SCLK\_F pulses when EN\_H is high determines the 'Receive/Send' state of the in-guard Tx/Rx devices. When EN\_H is low, the Tx/Rx devices are placed into 'WAIT' state.

##### **TRK\_H**

This signal is not used.

##### **ERR\_L (Transfer Error Warning)**

During a write cycle the Tx/Rx devices compare the transmitted bytes of true data against their transmitted complements. If there is any disparity, ERR\_L is asserted. The ERR\_L line remains high when there are no errors.

The ERR\_L line can also be pulled low if a Tx/Rx device does not recognize the bit-pattern of its received true data as a valid command, or if its internal processing is defective.

##### **CI\_R (Conversion Initiate)**

This signal is used to initiate an A-D conversion. Once the correct trigger is present, and the analog sub-system has been configured by data transfers, and any digital delays have expired, the CI\_R line is set high. The rising edge of CI\_R into U509 on the DC PCB initiates a reading conversion. At the same time, for AC measurements, the frequency counter M412 on the AC PCB is activated.

##### **RTX\_R (Conversion and Count Complete)**

The A-D ULA (U509 on the DC PCB) has an open-collector output RTX1, which is pulled low during a conversion as a result of CI\_R. Once the conversion is completed the A-D ULA turns its open-collector device off. Similarly the frequency counter (M412 on the AC PCB) has an open-collector output RTX2, which CI\_R causes to be pulled to low.

Once the count is complete RTX2 is released from low. When both RTX1 and RTX2 have been released, pull-up resistors on the DC PCB set the RTX line to high. This is passed through isolator U805 to the Digital ASIC, where the rising edge signifies that the two operations are finished.

5.2.8.5 WRITE Cycle

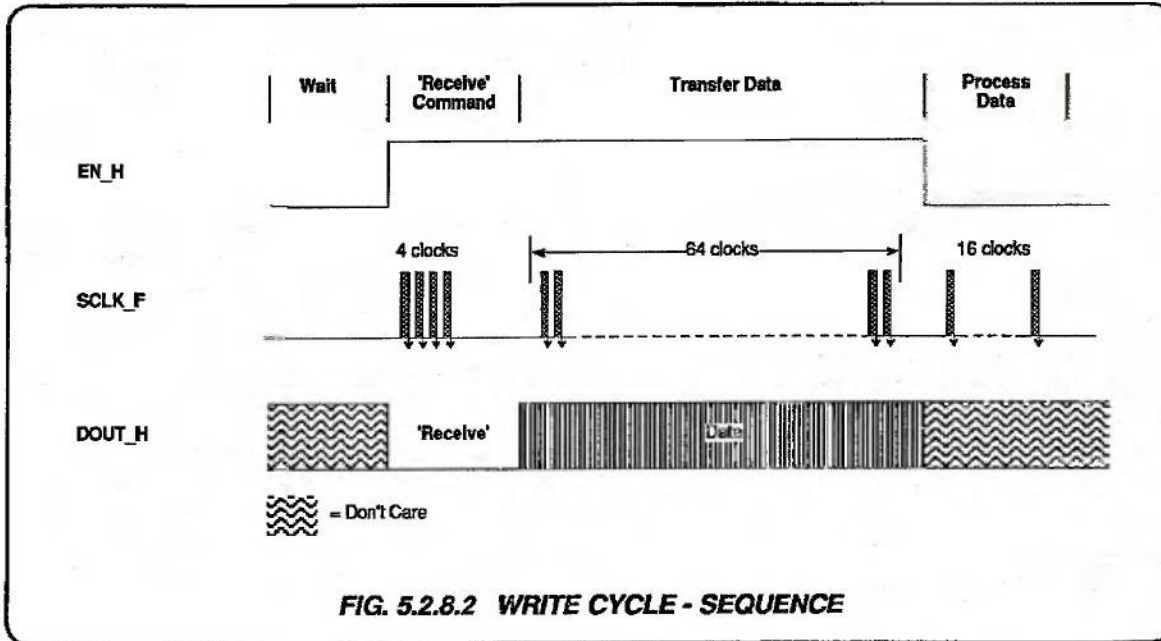

There are four phases in the cycle, controlled by EN\_H, SCLK\_F and the data line DOUT\_H itself. They are:

**Wait:**

EN\_H is low, no clock pulses are present. All in-guard Tx/Rx devices ignore any data on the data line, which bypasses their serial registers.

**Instruct All Tx/Rx Devices to Receive:**

EN\_H goes high to enable the data transfer, and DOUT\_H is set low. Four SCLK\_F pulses are transmitted, while DOUT\_H is held low, to announce that the processor is about to command a change of instrument analog state. The in-guard Tx/Rx devices activate to receive data from DOUT\_H, placing their serial registers into the data path. During the time taken to place the registers on line at the start of EN\_H true, the inputs and outputs of the Tx/Rx devices are still shorted, so the whole of the signal path has time to fall to low.

**Transfer Data:**

EN\_H remains high. The 64 serial data bits of the first group are injected into the data path via DOUT\_H, a bit at a time, while 64 SCLK\_F pulses clock the bits through the serial registers of the Tx/Rx devices. This transmission of 64-bit groups continues until the data is located in the correct Tx/Rx serial registers for the instrument's option fit. Each 8-bit device in fact introduces a 16-bit serial register into the data path, half for a true data byte, the other half for its following complement data byte. This allows error checking in the Process Data phase.

**Process Data:**

EN\_H goes low to disable the data transfer. The data in the Tx/Rx serial data registers is held, as the registers are taken out of the data path. Sixteen SCLK\_F pulses are transmitted which cause the Tx/Rx devices to check the true data against its complement.

If there is no corruption, the true control data is latched into the device's DIO lines (a similar checking facility is incorporated into the A-D and frequency counter ULAs, but correct true data is latched internally). The data is used to reconfigure the analog circuits controlled by the device.

If a device discovers an error, it pulls its ERR\_L line low, and latches its DIO lines at high impedance. In this condition, a set of pull up/down resistors dominates the device's DIO output lines, setting a safe analog state.

ERR\_L is an open-collector output and input. When it is pulled low for an error by one device, the change is detected by all the other devices in the loop, which also set their DIO lines to high impedance (but without latching). This causes the whole analog sub-system to revert to a safe condition.

There is a further benefit in latching only the device which detected the error. When fault-finding, if the Tx/Rx chips are removed one at a time, then the ERR\_L line will remain low until the one which reported the error is removed. This locates the part of the data stream which is corrupted, as a lead-in to subsequent diagnosis.



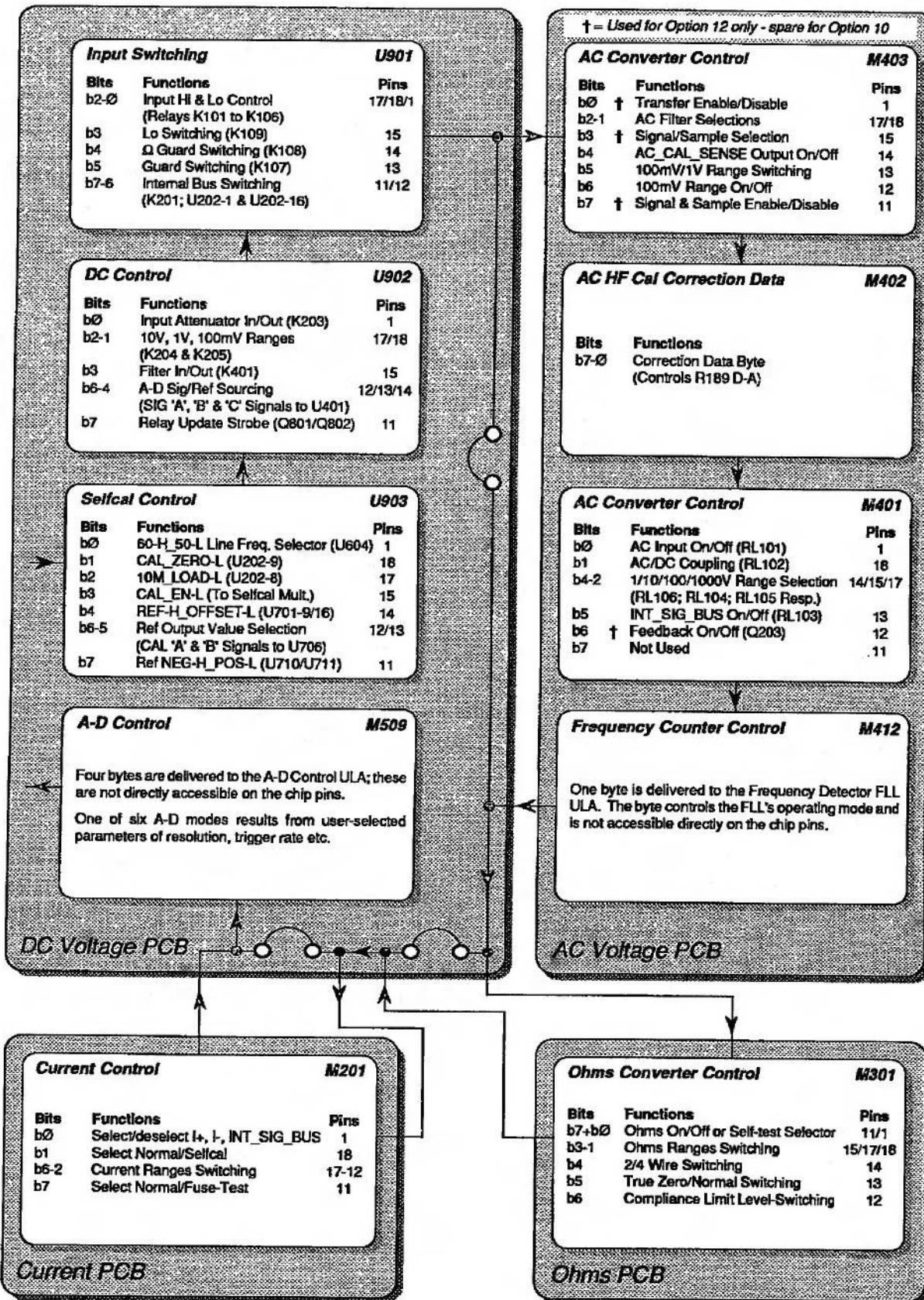

FIG. 5.2.8.3 SERIAL INTERFACE REGISTERS - COMMAND DATA (DEVICES SET TO RECEIVE)



5.2.8.6 READ Cycle

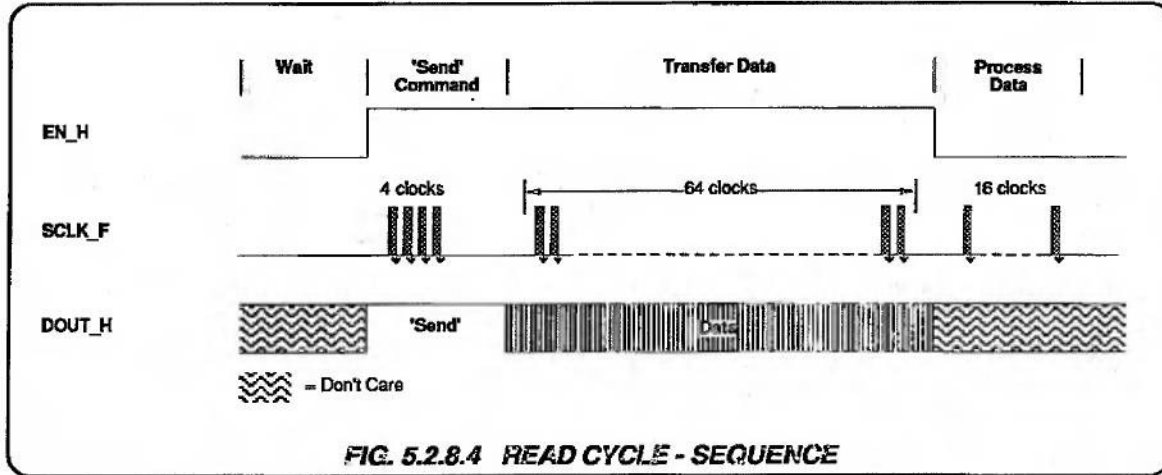

FIG. 5.2.8.4 READ CYCLE - SEQUENCE

There are four phases in the read cycle, also controlled by EN\_H, SCLK\_F and the data line DOUT\_H. They are:

**Wait:**

EN\_H is low, no clock pulses are present. All in-guard Tx/Rx devices ignore any data on the data line, which bypasses their serial registers.

**Instruct All Tx/Rx Devices into their Preset Send Modes:**

EN\_H goes high to enable the data transfer. Four SCLK\_F pulses are transmitted, while DOUT\_H is held high, to announce that the processor is about to command the 'Send' devices to transmit data. The 8-bit in-guard Tx/Rx devices are preset in hardware as 'receiver only' and so assume the 'Wait' condition, in which they are transparent to signals on the serial data path. The A-D and Frequency ULAs activate to transmit data via DRET\_H, placing their serial registers into the data path. During the time taken to place the registers on line at the start of EN\_H true, the inputs and outputs of the Tx/Rx devices are still shorted, so the whole of the signal path has time to rise to high.

**Transfer Data:**

EN\_H remains high. 64 preset serial data bits of the first group are injected into the data path via DOUT\_H, a bit at a time, while 64 SCLK\_F pulses clock the bits through the A-D and Frequency ULA serial registers. This transmission of 64-bit groups continues until the preset data is returned to the digital ASIC serial registers. The two ULAs introduce both true and complement data bytes, to permit error checking by the digital ASIC during the Process Data phase.

**Process Data:**

EN\_H goes low to disable the data transfer. The data in the Tx/Rx serial data registers is held, as the registers are taken out of the data path. Sixteen SCLK\_F pulses are transmitted which cause the two ULAs to check the preset data against its complement. During this time the ASIC checks the returned true and complement data from the ULAs.

If there is no corruption, the returned true data is transferred to the processor.



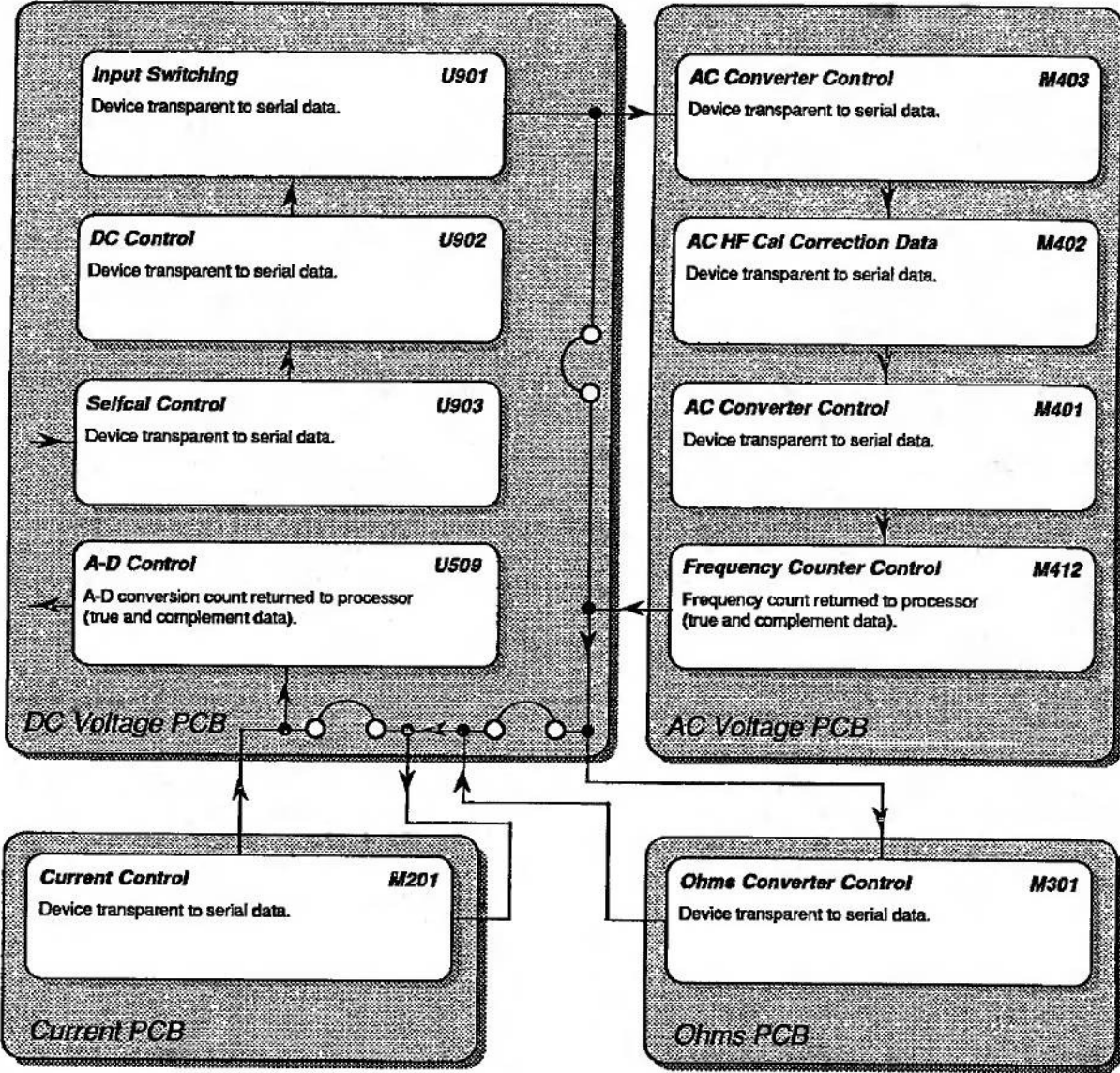

FIG. 5.2.8.5 SERIAL INTERFACE REGISTERS - MEASUREMENT DATA (DEVICES SET TO SEND)



**5.2.8.7 Option Test**

*N.B. It is assumed that all instruments will contain an A-D converter, so the A-D ULA is excluded from the Option Test procedure.*

**Introduction**

This is one of the first transfer commands from the processor to the Interface Controller following a Reset (including the power-up reset). It is included so that the processor can discover which options are fitted in the instrument, to enable the correct firmware options to be selected: e.g. how many 64-bit groups are required for a complete transfer during the write cycle (the read cycle is fixed at one group only). The facility caters for recognition of other future options which may be fitted in place of the standard options. Option Test also serves to set the analog sub-system to a known safe state before it is configured into the default mode.

The 8-bit Tx/Rx devices are preset in hardware to act only as receivers, but they are designed so that this preset can be overridden when commanded via the serial interface. Once overridden, they can revert to 'receiver only' only when the override is cancelled by a write cycle, or after a reset.

The Option Test command generates three transfers, overriding the hardware preset. The first two are abbreviated Read cycles, which command all Tx/Rx devices (except the A-D ULA) to convert into 'Senders' and set their DIO lines at high impedance. The analog sub-system is thus configured safe by the dominant pull-up/down resistors on the DIO lines. This imposes a unique bit-pattern for each Tx/Rx, which is detected by the device as an input from the DIO lines, and is loaded (with its complement data) into the device's serial register in the serial data path.

The third transfer is a standard Read cycle, which passes the data from the Tx/Rx devices to the digital ASIC. After checking for errors, the ASIC releases the data for the processor to read. The processor interprets the unique bit-patterns as 'options fitted' information.

**Wait:**

EN\_H is low, no clock pulses are present. All in-guard Tx/Rx devices ignore any data on the data line, which bypasses their serial registers.

**Instruct Tx/Rx Devices to Select Option Test Mode:**

EN\_H goes high. Four SCLK\_F pulses are transmitted, while DOUT\_H is held high. EN\_H immediately returns to low, and 16 SCLK\_F pulses are transmitted to clock the 'Process Data' sequence in the Tx/Rx devices. Each in-guard Tx/Rx device (except the A-D ULA) interprets this sequence as the overriding 'All Send Option Data' command. It reconfigures itself as a sender, setting its DIO lines at high impedance and loading the DIO bit-pattern into its serial register. During the time taken to place the registers on line at the start of EN\_H true, the inputs and outputs of the Tx/Rx devices are still shorted, so the whole of the signal path has time to rise to high.

To ensure that the Tx/Rx devices have enough time to reconfigure themselves, the instruction is repeated a second time.

**Instruct Tx/Rx Devices to Send Data:**

The processor commands a Read cycle to obtain the option state. Because the option fit is not known at this point, it is necessary for this cycle to return 4 x 64-bit groups (required for the possibility that the instrument is fully-loaded).

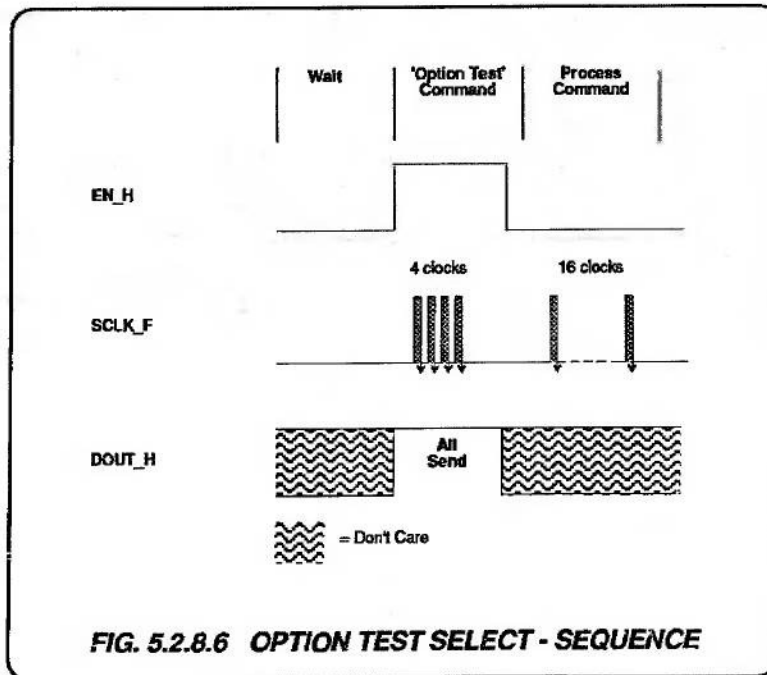

**FIG. 5.2.8.6 OPTION TEST SELECT - SEQUENCE**



### 5.2.8.8 Power On and Reset

#### Interface Flushing

At power on, the digital master reset MR\_L is asserted, to be turned off after 200ms-300ms. The Tx/Rx device serial data registers could power up any random condition, so they must be initialized. The first action by the processor on the interface is to flush the in-guard data path by 16 SCLK\_F pulses, while DOUT\_H and EN\_H are held low. The Tx/Rx devices' are thus in the safe 'Wait' state, their DIO lines being at high impedance due to EN\_H being low, serial data registers off-line, and serial data inputs and outputs shorted together. The 16 SCLK\_F pulses are therefore sufficient to set the whole of the serial data path to low.

#### Interface Reset

Two Write cycles are processed with DOUT\_H remaining low. This time the Tx/Rx registers are put into the serial data path by EN\_H high, and are all reset to zero by the low on the data path. This is a safe state, and after the reset the Tx/Rx devices return to 'Wait' state.

#### Option Test

Two option test commands are transmitted to ensure that all Tx/Rx devices are forced to become senders, then a Read cycle is processed, using four 64-bit groups so that a complete test of all options will be completed if the instrument is fully loaded. If an interface error occurs at this time the processor will abort the option test, deal with the error, and then re-start the test.

The Tx/Rx devices remain in their 'Wait' condition, imposing the Power On Reset (default) condition on the analog sub-system, until a Write cycle is processed to change their serial register contents. The processor now knows the instrument's option fit, and so tailors subsequent interface operations to accommodate the correct number and positions of the serial registers in the serial data path.

#### A-D Action

After the digital master reset has been removed, CI\_R remains inactive until the option test has been successfully completed, to allow the A-D ULA to stabilize the A-D analog circuit. With 0V at its signal input, the A-D powers up with its integrator output positive, and the A-D ULA imposes +REF/256 to return this very slowly towards zero. Meanwhile, during the master reset period, the A-D and Frequency ULAs had released their open-circuit RTX\_R outputs, which remain pulled to high.

After the Option Test has been completed successfully, a conversion is initiated by CI\_R being set high for some 30ms. The rising edge of CI\_R has the effect of imposing +REF at the A-D input, which rapidly drives the A-D output to zero, and the A-D starts a conversion with zero input. At the same time the RTX\_R line is forced low. The processor waits for the RTX\_R line to rise to high again to show that this first conversion has been completed. If this does not happen within 2.25 seconds, the processor assumes that an A-D fault is present.

A successful first conversion sets RTX\_R back to high, and the interface power-on sequence is complete. Unless the instrument is commanded otherwise, the power-on default state persists, and the A-D is internally triggered continuously to produce 6.5-digit normal conversions (16 power line cycles).



## Datron Sales and Service Representatives Worldwide

COUNTRY and REPRESENTATIVE	Telephone	Telex	Fax
<b>AUSTRALIA</b>			
Scientific Devices Pty. Ltd 2 Jacks Road, South Oakleigh, Victoria 3167	3 579 3622	AA32742	3 579 0971
<b>AUSTRIA</b>			
Walter Rekersch Elektronisch Geraete GmbH & Co. Obachgasse 28, A-1220 Wien	222 253626	134759	222 2572 75
<b>BELGIUM</b>			
Air-Parts International B. V. Avenue Huart-Hamoir, 1-Box 34, 1030 Bruxelles	2 241 6460	25146 AP1 B	2 241 8130
<b> BRAZIL</b>			
Comercial Goncalves Rua Deocleciana, 77, Cep 01106 Ponte Pequena, Sao Paulo SP	11 2294044	22104 34272	---
<b>CHINA</b>			
Tianjin Zhong Huan Scientific Instruments Corp. No. 59 Zhao Jia Chang Street, Hong Qiao Section, Tianjin	Tianjin 753732	---	---
<b>DENMARK</b>			
Instrutek A/S, Christiansholmsgade 8700 Horsens	5 611100	61656	5 615 658
<b>EASTERN EUROPE</b>			
Amtest Associates Ltd Amtest House, 75-79 Guildford Street, Chertsey, Surrey KT16 9AS, England	0932 568355	928855	0932 561919
<b>EGYPT &amp; MIDDLE EAST</b>			
<b>EPIC</b>			
20-22 Ashmoun St, PO Box 2682, Horriya, Heliopolis	2 661767 2 669861	23033 CHAKA UN 23315 EPIC UN	2 662839 2 668924
<b>FINLAND</b>			
Profelec OY PO Box 67, 00421 Helsinki 42	0 566 4477	125225 PROFE SF	0 566 2998



COUNTRY and REPRESENTATIVE	Telephone	Telex	Fax
<b>FRANCE</b>			
M. B. Electronique 606 Rue Fourny, Zi de Buc, 78530 Buc	1 39 568131	695414	1 39 565344
<b>WEST GERMANY</b>			
Wavetek Electronics GmbH Hans-Pinsel Strasse 9-10, 8013 Haar bei München	89 461090	841 5211296 WVTKD	89 463223
<b>GREECE</b>			
American Technical Enterprises SA PO Box 3156, 48 Patisson Street, Athens 147	1 8219470	216046 ATE GR	—
<b>HONG KONG</b>			
Eurotherm (Far East) Ltd 21/F Kai Tak Commercial Building 317-321 Des Voeux Road C, Hong Kong	5 411268	72449 EFELD HX	5 8151540
<b>INDIA</b>			
Technical Trade Links 42, Navketan Estate, Mahakali Caves Road, Andheri (East), Post Box No. 9447, Bombay 400 093	22 6322412	11 79261 TTL IN	9122 634 2204
<b>IRELAND</b>			
Euro Instruments & Electronics Euro House, Swords Road, Santry, Dublin 9	0001 425 666	318121	0001 425 497
<b>ISRAEL</b>			
Racom Electronics Co. Ltd 7 Kehilat Saloniki St., P. O. Box 21120, Tel-Aviv 61210	3 491922	33808 RACEL IL	3 491 576
<b>ITALY(1)</b>			
Sistrel SPA Via Pellizza da Volpedo 59 20092 Cinisello Balsamo, Milano	02 618 1893	334643	02 618 2440
<b>ITALY(2)</b>			
Sistrel SPA Viale Erminio Spalla 41 00142 Roma	06 504 0273	625857	06 504 0067
<b>ITALY(3)</b>			
Sistrel SPA Via Cintia Parco S. Paolo 35 80126 Napoli	081 767 9700	—	081 766 1361
<b>JAPAN</b>			
G & G Japan Inc No. 406, 12-14, 4-Chome, Hongoh, Bunkyo-ku, Tokyo	3 8130971	2722884 ICHAIN J	3 8159216
<b>KOREA</b>			
Sama Trading Corporation CPO Box 2447, Seoul	2 733 9336	K26375 SAMATR	2 733 8481

COUNTRY and REPRESENTATIVE	Telephone	Telex	Fax
<b>MALAYSIA</b> TME Systems Pte Ltd 21 Moonstone Lane, No. 06-01, Poh Leng Building, Singapore 1232	286 4608	786 37545	288 5935
<b>NETHERLANDS</b> Air Parts International BV PO Box 255, 12 Kalkovenweg, 2400 AG Alphen aan den Rijn	1720 43221	39564	1720 20651
<b>NEW ZEALAND</b> G. T. S. Engineering Ltd 5 Porters Avenue, Eden Terrace, PO Box 9613 Newmarket AUCKLAND	9 392 464	----	9 392 968
<b>NORWAY</b> Morgenstjerne & Co. Konghellegaten 3/5, 0569 Oslo 5	2 356110	71 719 MOROF	2 381457
<b>PORTUGAL</b> Decada SA Rua Margarida, Palla. 11, 1495 Alges.	1 4103420	24476 ESPEC P	1 4101844
<b>SINGAPORE</b> Mecomb Singapore Ltd Sime Darby Centre, 895 Dunearn Road, 04-2 Singapore 2158	469 8833	RS 23178	467 1905
<b>SOUTH AFRICA</b> Altech Instruments (Pty) Ltd PO Box 39451, Wynberg 2018	11 887 7455	422033	---
<b>SPAIN</b> ESSA (Equipos y Sistemas SA) C/Apolonio Morales 13-B, Madrid 16	1 458 0150	831 42856	----
<b>SWEDEN</b> Ferner Electronics AB Snormakarvagen 35, Box 125, S-16126 Stockholm-Bromma	8 802540	10312 FERNER S	8 250226
<b>SWITZERLAND</b> Kontron Electronic AG Bernerstrasse-Stüd 169, 8048 Zurich	1 435 4111	822196 + KOEL CH	1 432 2464
<b>TAIWAN</b> Evergo Corporation Room A, 9th Floor, 305 Section, 3 Nan King East Road, P. O. Box 96-546, Taipei	2 7150283/4/5	27027 EVERGOEC	2 7122466